

FINAL REPORT

VOLUME 1

SUMMARY AND RECOMMENDATIONS IN VOLUMES 1-3  
SEISMICITY, SOILS AND THE SEISMIC DESIGN OF BUILDINGS



A



B

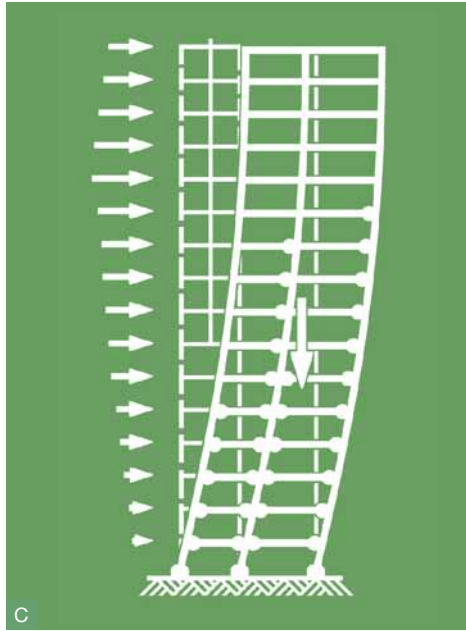

C

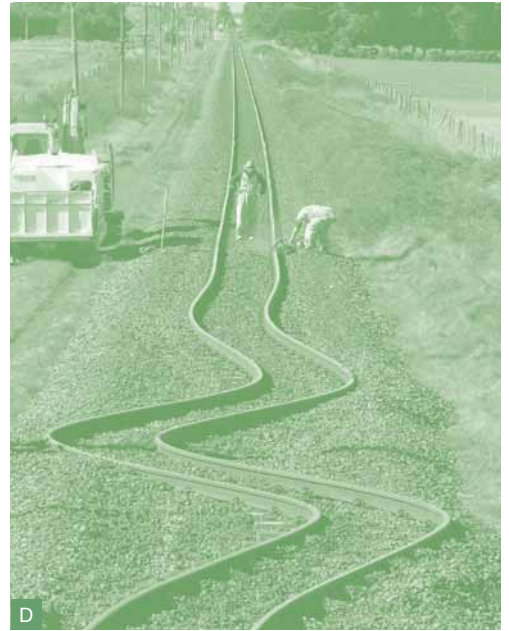

D

- A. Silt crater resulting from liquefaction after the 22 February 2011 earthquake (source: George Kuek)
- B. Rupture in a Christchurch park as the result of the 4 September 2010 earthquake (source: Ministry of Civil Defence & Emergency Management)
- C. Past experiences and research into the response of structures during severe earthquakes has led to significant advances in guidance for the analysis and design of buildings. This image is sourced from the text 'Seismic Design of Reinforced Concrete and Masonry Buildings', which is a publication by leading New Zealand earthquake engineers Thomas Paulay and Nigel Priestley
- D. Earthquake shockwaves preserved in rail tracks (source: Ministry of Civil Defence & Emergency Management)

ISBN: 978-0-478-39558-7  
(Final Report web-quality PDF)

ISBN: 978-0-478-39559-4  
(Volume 1 web-quality PDF)

---

# Letter of Transmittal

---

To His Excellency, Lieutenant General The Right Honourable Sir Jerry Mateparae GNZM, QSO Governor-General of New Zealand

Your Excellency

Pursuant to the Orders in Council dated 11 April 2011 and 7 February 2012 appointing us to be a Royal Commission of Inquiry into Building Failure caused by the Canterbury Earthquakes and to provide a Final Report not later than 12 November 2012, with a first part delivered by 29 June 2012, we now humbly submit the first part of our Final Report for Your Excellency's consideration.

We have the honour to be

Your Excellency's most obedient servants



**Hon Justice Mark Cooper (Chairperson)**



**Sir Ronald Carter**



**Adjunct Associate Professor Richard Fenwick**

Dated at Wellington this 29th day of June 2012.

# Contents

---

Letter of transmittal	1
Introduction	3
<b>Section 1: Summary and recommendations – Volumes 1–3</b>	<b>7</b>
<b>Section 2: Seismicity</b>	<b>15</b>
2.1 Introduction	15
2.2 The Royal Commission’s approach	15
2.3 New Zealand’s tectonic setting	16
2.4 Faults	20
2.5 Active faults in the Canterbury region	21
2.6 Earthquakes	25
2.7 The Canterbury earthquakes	28
2.8 The New Zealand National Seismic Hazard Model	42
2.9 Conclusions	47
<b>Annex 1: Tectonic structure of the Canterbury region</b>	<b>48</b>
<b>Section 3: Introduction to the seismic design of buildings</b>	<b>53</b>
3.1 Structural actions	53
3.2 Seismic design of buildings	54
3.3 Analysis of seismic actions	62
3.4 Different structural forms in buildings	69
<b>Section 4: Soils and foundations</b>	<b>73</b>
4.1 Introduction	73
4.2 Expert advice	73
4.3 Canterbury soils	73
4.4 Soils in the Christchurch CBD	74
4.5 Role of soils in an earthquake	75
4.6 Soil liquefaction and lateral spreading	75
4.7 Damage to structures	76
4.8 Impact of Alpine Fault rupture	77
4.9 Canterbury earthquakes: performance of foundations	78
4.10 Seismic design and construction of building foundations in CBDs of New Zealand cities	79
<b>Appendix 1: Terms of Reference</b>	<b>92</b>
<b>Appendix 2: Expert advisers</b>	<b>98</b>
<b>Appendix 3: Submitters and witnesses</b>	<b>100</b>
<b>Appendix 4: Glossary of terms</b>	<b>108</b>

---

---

# Introduction

---

On 4 September 2010, at 4:35am, an earthquake of magnitude 7.1 struck Christchurch and the surrounding Canterbury region. The earthquake had an epicentre near Darfield, a small town about 40km west of the Christchurch Central Business District. An aftershock sequence began, which at the time of writing is ongoing. All of the earthquakes were the result of ruptures on faults not known to be active prior to the September event.

The early morning timing of the September earthquake and the rural location of its epicentre no doubt prevented fatalities. However, many unreinforced masonry buildings were damaged and there was extensive damage to infrastructure. The eastern suburbs of Christchurch and Kaiapoi were seriously affected by liquefaction and lateral spreading of the ground.

The September earthquake was followed by four other major earthquakes occurring on Boxing Day 2010, and 22 February, 13 June and 23 December 2011. Of these, the event on 22 February was by far the most serious, resulting in 185 deaths. It led to the establishment on 11 April 2011 of this Royal Commission of Inquiry into Building Failure Caused by the Canterbury Earthquakes.

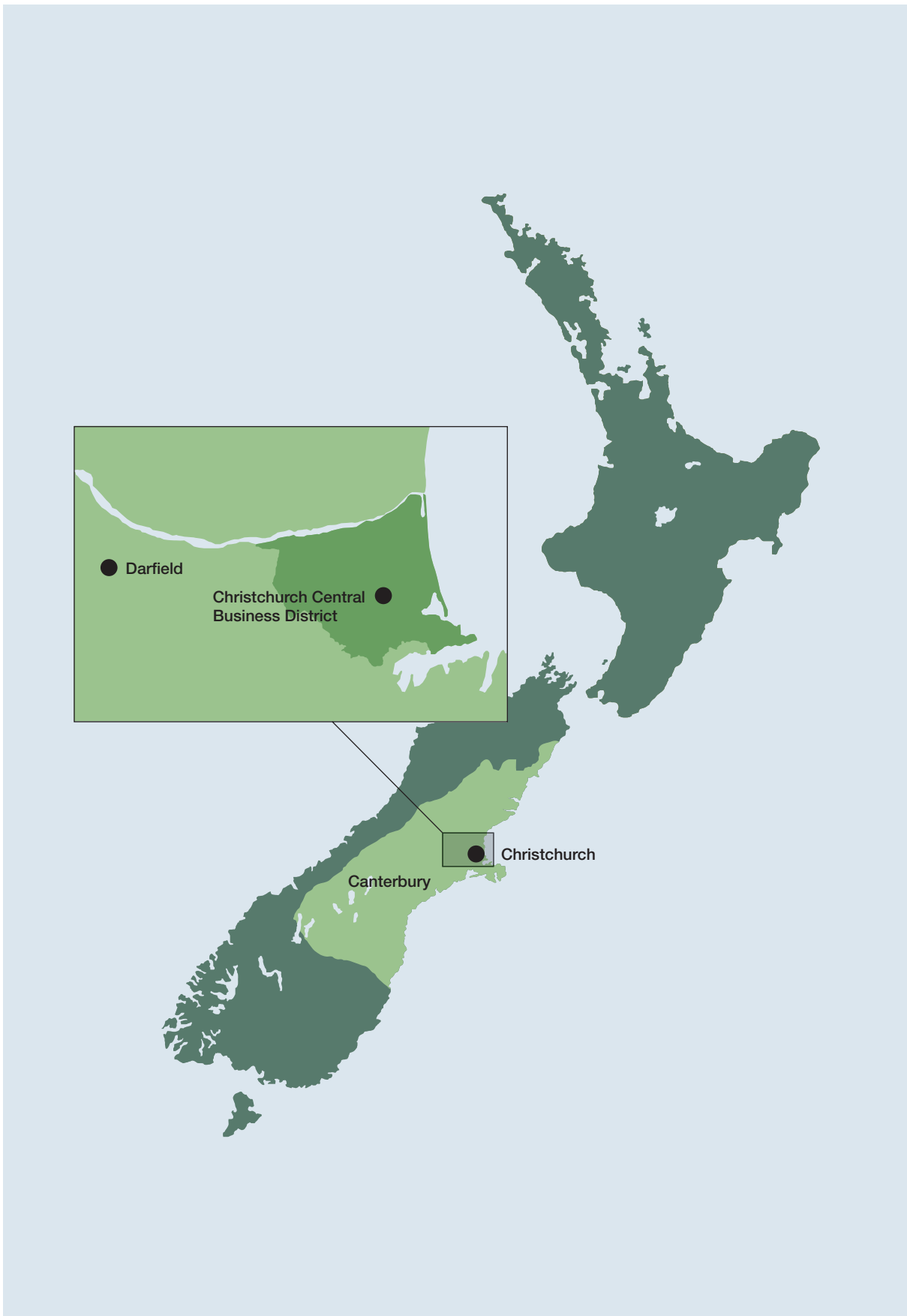

Map of New Zealand showing Canterbury region

The February earthquake struck on a Tuesday, at 12:51pm. The centre of Christchurch was full of people going about their business in New Zealand's second largest city and there were many tourists. The earthquake had a magnitude of 6.2. The fault that ruptured was at a shallow depth and had an epicentre in the Port Hills, just to the south of Christchurch. The earthquake had devastating consequences. Two buildings collapsed catastrophically, the Canterbury Television (CTV) and Pyne Gould Corporation (PGC) buildings, where respectively 115 and 18 people lost their lives and others were seriously injured. Failure of other buildings caused the deaths of 42 people and again resulted in many injuries. Ten people lost their lives for reasons not related to building failure, including rock falls. Of those killed, 77 were foreign nationals.

As a result of the earthquakes, the CBD was also altered irrevocably. At the time of writing, in May 2012, the Canterbury Earthquake Recovery Authority (CERA) estimated that there had been 655 building demolitions in the CBD, with a further 100 under way. It was projected that the total number of demolitions would be about 1100. This has had a huge economic impact, but there has also been a great social and cultural cost in terms of the loss of historic buildings and cultural facilities.

The Royal Commission's Terms of Reference are set out in Appendix 1. They mandate an inquiry in two broad parts. The first concerns the performance in the earthquakes of a representative sample of buildings in the Christchurch CBD, bound by Bealey, Fitzgerald, Moorhouse, Deans and Harper Avenues. The second is about the adequacy of the current legal and best-practice requirements for design, construction and maintenance of buildings in central business districts in New Zealand to address the known risk of earthquakes. The Terms of Reference provide that the Royal Commission must make recommendations upon or for:

- (a) any measures necessary or desirable to prevent or minimise the failure of buildings in New Zealand due to earthquakes likely to occur during the lifetime of those buildings; and
- (b) the cost of those measures; and
- (c) the adequacy of legal and best-practice requirements for building design, construction, and maintenance insofar as those requirements apply to managing risks of building failure caused by earthquakes.

Some matters were specifically excluded from the inquiry. They included the role and response of those acting under the Civil Defence Emergency Management

Act 2002 or providing any emergency or recovery services or other response, after the February earthquake. Also excluded were matters that are the responsibility of other agencies or bodies, "such as the design, planning, or options for rebuilding in the Christchurch CBD".

As required by the Terms of Reference, the Royal Commission provided an Interim Report to the Governor-General in October 2011. In accordance with the Terms, the Interim Report included recommendations intended to inform early decision making and repair work that would form part of the recovery from the earthquakes.

We were unable, however, to comply with the instruction in the Terms of Reference that the Final Report be provided not later than 11 April 2012, and in February 2012 the Terms were modified to instruct us to report and make final recommendations:

- (a) not later than 29 June 2012, on matters that will inform early decision making on rebuilding and repair work that forms part of the recovery from the earthquakes; and
- (b) at any time before 12 November 2012 on any other matter, if we are able to do so; and
- (c) not later than 12 November 2012, on all matters on which we have not otherwise reported.

The Modifications to the Terms of Reference are set out in Appendix 1.

This change meant that we are able to provide our Final Report in stages, and to make recommendations on matters particularly relevant to the redevelopment of the Christchurch CBD at an earlier stage than would otherwise have been the case.

This first part of the Royal Commission's Final Report is in three Volumes. They are:

Volume 1: which gathers together the recommendations made in all three Volumes, and also includes discussion of seismicity, the seismic design of buildings, soils and geotechnical considerations.

Volume 2: which covers the representative sample of buildings, excluding the CTV building and earthquake-prone buildings.

Volume 3: which discusses engineering technologies available to reduce earthquake damage to buildings.



The content of these volumes focuses on some matters that are relevant to the inquiry as a whole (seismicity and the seismic design of buildings) as well as issues particularly relevant to the rebuild of Christchurch (the geotechnical issues discussed in Volume 1, the conclusions and recommendations in Volume 2 and the discussion of low-damage technologies in Volume 3). Volume 2 contains our findings on the representative sample of buildings, with the exception of the CTV building and earthquake-prone buildings. Those subjects will be addressed in subsequent volumes, as will the other issues on which we are required to report.

It is appropriate to make here some general observations that we consider justified by the detailed discussion set out in these volumes. First, the September and February earthquakes were events likely to have long recurrence intervals, in each case greater than 8000 years. Second, the February earthquake tested the resilience of normal commercial buildings to an extent beyond the levels of shaking used for the purposes of design in current New Zealand Standards.

As noted in our Interim Report, and repeated in Volume 2 of this Report, there is an urgent need to reconsider the design of stairs in multi-storey buildings so as to avoid a repeat of the collapses that occurred in the Forsyth Barr, Hotel Grand Chancellor and other buildings. Those collapses could have had tragic consequences, and it is very fortunate that they did not lead to loss of life. They point to the need to ensure to the extent possible that means of egress from buildings remain available for use after an earthquake. We are aware that the Department of Building and Housing (DBH) has already taken action on this subject. Otherwise, with the exception of the CTV and PGC buildings, modern commercial buildings generally performed in accordance with the key objective of life-safety set by the Building Code.

We have concluded that confidence is justified in the current processes by which earthquake risk in New Zealand is assessed and translated into the provisions of the relevant Standards used for the purposes of building design. We are satisfied that there is no need to change the existing process for setting the “z” value that plays a crucial role in the design of buildings for earthquake resistance. For reasons addressed in Volume 2, we conclude that the construction costs do not appear to increase significantly with increases in the seismic design factor of the magnitude that has occurred (or may be contemplated) in Christchurch. Further, it would not be sensible, in our opinion, to conclude that the performance of buildings in the February earthquake demonstrates a need for wholesale change.

There are nevertheless aspects of current design practices and Standards that can and should be enhanced, and these are the subject of particular recommendations that we make. We have not been able to specifically verify the cost increment resulting from the recommendations we make because the costs will depend to a significant degree on the design of individual buildings and the soil conditions of the site. However, we consider they are necessary to address or mitigate what we have observed from the earthquakes. We have also identified a need for further research into some of the problems that we discuss. But we consider that the objective should be incremental improvement, rather than a change of direction, and the necessary improvements can be incorporated within the framework of the present rules.

There is no doubt that the economic, social and cultural consequences of the earthquakes have been very severe. There is also no doubt that design approaches to mitigate damage should be adopted where it is economically feasible to do so. It is for that reason that we have dealt with the low-damage technologies discussed in Volume 3. However, once the objective of life-safety is achieved, the question of the extent to which buildings should be designed to avoid damage is a social and economic one, and the answer depends on choices that society as a whole must make.

The Terms of Reference require the consideration of “best-practice requirements for the design, construction and maintenance of buildings”, and do not embrace broader societal issues and the decisions that will need to be made in rebuilding the Christchurch CBD. In the circumstances, our concept of “best practice” is one that reflects the existing objective of life-safety, and looks to ensure that building damage is minimised within the limits established by the existing knowledge about earthquake risk and our understanding of the cost implications of more onerous requirements. Any other approach would be a radical change that we do not consider would be justified by the experience of the Canterbury earthquakes.



# Section 1: Summary and recommendations – Volumes 1–3

---

## Volume 1: Seismicity, soils and the seismic design of buildings

### Section 2: Seismicity

In this section the Royal Commission discusses the forces giving rise to earthquakes in New Zealand generally, and the active faults in the Canterbury region. We refer to earthquakes that have occurred historically and describe the nature and characteristics of the Canterbury earthquakes. We describe the New Zealand National Seismic Hazard Model and alterations that have been made to the model, noting in particular the way in which GNS Science has responded to the implications of the Canterbury earthquakes.

The Royal Commission considers that confidence is justified in the knowledge and expertise of GNS Science with respect to the seismicity of New Zealand. The way in which the knowledge of earthquake risk is reflected in the ongoing development of building standards is appropriate.

## Recommendations

---

We recommend that:

1. Research continues into the location of active faults near Christchurch and other population centres in New Zealand, to build as complete a picture as possible for cities and major towns.
2. The provisions of the Earthquake Actions Standard, NZS 1170.5, relating to vertical accelerations be reviewed. (See also recommendations 33 and 34 below.)

### Section 3: Introduction to the seismic design of buildings

This section outlines the concepts, theory and methods of practice used to design buildings that can withstand earthquakes.

There are no recommendations associated with this section.

### Section 4: Soils and foundations

The soils in the Christchurch CBD, being highly variable both horizontally and vertically across short distances, pose challenges for the design of structures and their foundations to withstand the potential impact of future large earthquakes. The Royal Commission considers that there must be greater focus on geotechnical investigations to reduce the risk of unsatisfactory foundation performance.

Tonkin and Taylor, for the Christchurch City Council (CCC), evaluated the nature and variability of subsurface conditions in the Christchurch CBD and adjacent commercial areas to the south and north-east. This will be held in a database available to the public. This information will be of assistance in assessing the potential need for land improvement, in the selection of appropriate foundation types, and in the planning of detailed investigation of foundation soils.

We make detailed recommendations in respect of site investigations, ground improvement and foundations design. Some recommendations are of particular relevance in the Christchurch CBD but many are of wider application.

# Recommendations

We recommend that:

## Geotechnical considerations

3. A thorough and detailed geotechnical investigation of each building site, leading to development of a full site model, should be recognised as a key requirement for achieving good foundation performance.
4. There should be greater focus on geotechnical investigations to reduce the risk of unsatisfactory foundation performance. The Department of Building and Housing should lead the development of guidelines to ensure a more uniform standard for future investigations and as an aid to engineers and owners.
5. Geotechnical site reports and foundation design details should be kept on each property file by the territorial authority and made available for neighbouring site assessments by geotechnical engineers.
6. The Christchurch City Council should develop and maintain a publicly available database of information about the subsurface conditions in the Christchurch CBD, building on the information provided in the Tonkin and Taylor report. Other territorial authorities should consider developing and maintaining similar databases of their own.
7. Greater use should be made of in situ testing of soil properties by the cone penetrometer test (CPT), standard penetration test (SPT) or other appropriate methods.
8. The Department of Building and Housing should work with the New Zealand Geotechnical Society to update the existing guidelines for assessing liquefaction hazard to include new information and draw on experience from the Christchurch earthquakes.
9. Further research should be conducted into the performance of building foundations in the Christchurch CBD, including subsurface investigations as necessary, to better inform future practice.

## Foundation loadings and design philosophy

### *Serviceability limit state (SLS)*

10. Where liquefaction or significant softening may occur at a site for the SLS earthquake, buildings should be founded on well-engineered deep piles or on shallow foundations after well-engineered ground improvement is carried out.
11. Conservative assumptions should be made for soil parameters when assessing settlements for the SLS.

### *Ultimate limit state (ULS)*

12. Foundation deformations should be assessed for the ULS load cases and overstrength actions, not just foundation strength (capacity). Deformations should not add unduly to the ductility demand of the structure or prevent the intended structural response.
13. Guidelines for acceptable levels of foundation deformation for the ULS and overstrength load cases should be developed. The Department of Building and Housing should lead this process.

### **Strength-reduction factors**

14. The concessional strength-reduction factors in B1/VM4 for load cases involving earthquake load combinations and overstrength actions ( $\Phi_g = 0.8-0.9$ ) should be reassessed.
15. The strength-reduction factors in B1/VM4 should be revised to reflect international best practice including considerations of risk and reliability.
16. For shallow foundations, soil yielding should be avoided under lateral loading by applying appropriate strength-reduction factors.
17. For deep pile foundations, soil yielding should be permitted under lateral loading, provided that the piles have sufficient flexibility and ductility to accommodate the resulting displacements. In such cases, strength-reduction factors need not be applied.

### **Shallow foundation design**

18. The Department of Building and Housing should lead the development of detailed guidelines to address the design and use of shallow foundations.
19. The Department of Building and Housing should lead the development of more detailed guidance for designers regarding acceptable foundation deformations for the ultimate limit state (ULS).
20. Shallow foundations should be designed to resist the maximum design base shear of the building, so as to prevent sliding. Strength-reduction factors should be used.

### **Ground improvement**

21. The performance of ground improvement in Christchurch should be the subject of further research to better understand the reasons for observed variability in performance.
22. Ground improvement, where used, should be considered as part of the foundation system of a building and reliability factors included in the design procedures.
23. Ground-improvement techniques used as part of the foundation system for a multi-storey building should have a proven performance in earthquake case studies.
24. The Department of Building and Housing should consider the desirability of preparing national guidelines specifying design procedures for ground improvement, to provide more uniformity in approach and outcomes.

### **Deep foundation design**

25. Detailed guidelines for deep foundation design should be prepared to assist engineers and to provide more uniformity in practice. The Department of Building and Housing should lead this process.

### **Driven piles**

26. Because driven piles have significant advantages over other pile types for reducing settlements in earthquake-resistant design, building consent authorities should allow driven piles to be used in urban settings where practical.

### **Kinematic effects**

27. Where there is a risk of significant liquefaction, deep piles should be designed to accommodate an appropriate level of lateral movement of the surface crust even when they are far from any watercourse.

### **Lateral loading**

28. Base friction should not be included as a mechanism for lateral load transfer between the ground and the building when it is supported on deep piles.
29. If reliance is to be placed on passive resistance of downstand beams and other vertical building faces, a realistic appraisal of the relative stiffness of the load-displacement response of the passive resistance compared to the pile resistance should be made.
30. For buildings on deep piles, it is not essential that the calculated lateral capacity of the foundations should exceed the design base shear at the ULS, provided that the piles have sufficient flexibility and ductility to accommodate the resulting yield displacement and kinematic displacements.
31. There are major problems in the use of inclined piles where significant ground lateral movements may occur. Where the use of inclined piles is considered, the kinematic effects that may generate very large axial loads that could overload the pile and damage other parts of the structure connected to the pile should be considered.

## Volume 2: The performance of Christchurch CBD buildings

In this Volume we address the representative sample of buildings and lessons that can be learned from the performance of those buildings in the Canterbury earthquakes. We recommend that a number of changes be made to design practices and Standards to enhance the ability of buildings to resist earthquakes. In some cases, we have identified the need for further research. The rationale behind these recommendations is in section 9 of Volume 2.

### Recommendations

We recommend that:

#### Recommendations related to the Earthquake Actions Standard, NZS 1170.5

32. The response spectral shape factor,  $C(T)$ , for deep alluvial soils under Christchurch, should be revised. The likely change in spectral shape with earthquakes on more distant faults also needs to be considered.
33. The shape of response spectra for vertical ground motion should be revised.
34. The implications of vertical ground motion for seismic design actions should be considered and locations identified where high vertical accelerations may be expected in earthquakes.
35. The requirements for regularity in buildings, and for torsion due to the distance between the centre of mass and the centres of stiffness and strength, should be revised to recognise the implications of these parameters on observed behaviour.
36. Design actions for floors acting as diaphragms need to be more clearly identified in the Standard. This includes actions that arise from:
  - the weight of the floor and its associated gravity loading and the acceleration of the floor;
  - shear transfer between the lateral-force-resisting elements;
  - self-strain forces induced by elongation and bending of beams; and
  - local forces induced by structural elements such as T-shaped walls that have differing strengths for displacement in the forward and backward directions.

37. A more rational theoretical basis should be developed for ‘magnitude weighting’, which is used in the development of the design response spectra for structures.
38. Explanation should be added to the commentary to the Standard to explain:
  - the difference between design inter-storey, and peak inter-storey drifts; and
  - the influence of ductile behaviour on the shape profile of a multi-storey building.
39. The Standard should be amended to require that the supports of stairs and access ramps be designed to be capable of sustaining 1.5 times the peak inter-storey drift associated with the ultimate limit state, together with an appropriate allowance for construction tolerance and any potential elongation effects.

#### Recommendations related to the Concrete Structures Standard, NZS 3101:2006

40. A comprehensive study of the existing literature on the influence of the rate of loading on seismic performance of reinforced concrete structures should be undertaken to address the inconsistencies in the published opinions, and to make appropriate recommendations for design.
41. Research into the influence of the sequence of loading cycles on yield penetration of reinforcement into beam-column joints and the development zones of reinforcement is desirable.
42. Changes should be made to the Standard to ensure that yielding of reinforcement can extend beyond the immediate vicinity of a single primary crack, and that further research be carried out to refine design requirements related to crack control in structural walls.

43. The Standard should be modified to include requirements related to confinement of ductile walls.

For the ductile detailing length of ductile walls, transverse reinforcement shall be provided over the full length of the wall as follows:

- confinement of boundary regions shall be provided in accordance with NZS 3101:2006, clause 11.4.6, modified to provide confinement over the full length of the compression zone; and
- transverse reinforcement in the central portion of the wall shall satisfy the anti-buckling requirements of NZS 3101:2006, clause 11.4.6.3.

We note that earlier this year the Structural Engineering Society New Zealand Inc. (SESOC) published a draft recommendation to this effect.

44. As a short-term measure, where there is a ductile detailing length in the wall and the axial load ratio,  $N/A_g f'_c$ , equals or exceeds a value of 0.10, the ratio of the clear height between locations where the wall is laterally restrained to the wall thickness should not exceed the smaller of 10, or the value given by clause 11.4.2 in the Standard.

Research should also be carried out to establish more rational expressions for limiting the ratio of clear height to thickness, allowing for both the loading and the imposed deformations on walls.

45. Research should be carried out into stiffness degradation due to yielding in the structure and elongation of the plastic hinges, as this could be of considerable value in establishing acceptable design criteria.
46. Guidance should be given in the Standard on the expected magnitude of elongation that occurs with different magnitudes of material strain and structural designers should be required to account for this deformation in their designs.
47. Structural designers develop a greater awareness of the interactions between elements due to elongation so that allowance for adverse effects can be mitigated in the design; and guidance on these matters should be given in the commentary to the Standard.

48. The Standard should be revised to provide guidance on elongation of plastic hinges in beams. This should include:

- the width and location of cracks that may be induced in floor slabs at the junction of the floor and supporting beams and the disruption that these cracks may cause to membrane forces that transfer seismic forces to the lateral-force-resisting elements; and
- details of reinforcement required to ensure that the bars do not fail in tension at the cracks.

49. In the Commentary to the Standard attention should be drawn to the significant axial compression force that may be induced in beams by the restraint of floor slabs.
50. Low-friction bearing strips should be used to support double-Tee precast units to isolate the precast units and the supporting structure from friction forces.
51. Where clause 8.7.2.8 in the Standard permits the use of stirrups in the form of overlapping U-shaped bars, the proportion of these bars lapped in cover concrete should not exceed 0.5.

#### Issues related to the Structural Steel Standard, NZS 3404:2009

The Standard does not require redundancy in a building that relies on eccentrically braced frames (EBFs) for seismic resistance, to ensure that collapse cannot occur in the event of one or two active links failing. We consider there should be a requirement for redundancy in such buildings. This requirement might be satisfied by providing columns with sufficient strength and stiffness so that they could provide an alternative load path for a portion of the lateral force resisted by the EBFs in each frame.

## Recommendation

We recommend that:

52. The Standard should be amended to require a level of redundancy to be built into structures where eccentrically braced frames are used to provide seismic resistance.

### General issues related to structural design

These recommendations are directed to design engineers, and should be considered by the Structural Engineering Society New Zealand Inc., the New Zealand Geotechnical Society, the New Zealand Society for Earthquake Engineering Inc., the Institution of Professional Engineers New Zealand, and other interested bodies. They should also be addressed in continuing education courses. In some cases, information may appropriately be added to the commentary to NZS 1170.5.

## Recommendations

We recommend that:

53. There should be greater cooperation and dialogue between geotechnical and structural engineers.
54. Designers should define load paths to ensure that the details have sufficient strength and ductility to enable them to perform as required.
55. Structural engineers should assess the validity of basic assumptions made in their analyses.
56. Appropriate allowance should be made for ratcheting where this action may occur.
57. Structural engineers should be aware that current widely used methods of analysis do not predict elongation associated with flexural cracking and the formation of plastic hinges.
58. In designing details, compatibility in deformations is maintained between individual structural components.
59. Structural engineers should be aware of the relevance of the tensile strength of concrete and how it can influence structural behaviour.

### Particular issues relating to assessment of existing buildings

These recommendations are directed to design engineers, and should be considered by the Structural Engineering Society New Zealand Inc., the New Zealand Society for Earthquake Engineering Inc., the Institution of Professional Engineers New Zealand, and other interested bodies. They should also be addressed in continuing education courses.

## Recommendations

We recommend that:

60. Training or guidance should be provided so that structural engineers are aware of the following issues when assessing existing buildings:
  - a In a number of reinforced concrete buildings designed using Standards published prior to 1995, the columns that were provided primarily to support gravity loading had inadequate confinement reinforcement to enable them to sustain the inter-storey drifts associated with the ultimate limit state. There are a number of reasons for this:
    - first, it was not until 1995 that a requirement was introduced for all columns to have confinement reinforcement;
    - second, design inter-storey drifts calculated using Standards in use prior to 1995 gave smaller inter-storey drifts than the corresponding values found using current Standards. The difference arises from the use of stiffer section properties, the lack of a requirement for drifts associated with P-delta actions to be included, and the practice of taking the design inter-storey drift as 50 per cent of the peak value ( ${}^2/S_M$ ) while the ductility was calculated on the basis of ( ${}^4/S_M$ ).
  - b There are a number of structural weaknesses in existing buildings due to aspects of design not being adequately considered in earlier design Standards. The report by MacRae et al identifies many of these aspects.



- c In assessing the potential seismic performance, particular attention should be paid to ensuring that seismic gaps for isolating stairs or separating buildings, or parts of buildings, have been kept clear.

61. Where mesh has been used to transfer diaphragm forces that are critical for the stability of a building in a major earthquake, retrofit should be undertaken to ensure there is adequate ductility to sustain the load path.

#### Issues raised in our Interim Report related to structural design: means of egress

A number of recommendations were made in the Royal Commission’s Interim Report. All these have been addressed in greater detail in this report except the following.

It was proposed that a maximum considered earthquake limit state be introduced into the Earthquake Actions Standard, NZS 1170.5:2004. The intention was that this limit state be considered for the design of stairs, ramps and egress routes from buildings to ensure that these remained useable following a major earthquake. Having given further consideration to this issue, we now consider that the same objective can be achieved by a different approach that might better fit the existing framework of NZS 1170.5.

## Recommendations

We recommend that:

62. Critical elements such as stairs, ramps and egress routes from buildings should be designed to sustain the peak for inter-storey drifts equal to 1.5 times the inter-storey drift in the ultimate limit state. In calculating this inter-storey drift, appropriate allowance should be made for elongation in plastic hinges or rocking joints with an appropriate allowance for construction tolerance. NZS 1170.5:2004 and the relevant materials Standards should be modified to provide for this requirement.

#### Building elements that are not part of the primary structure

63. The principles of protecting life beyond ultimate limit state design should be applied to all elements of a building that may be a risk to life if they fail in an earthquake.

64. In designing a building, the overall structure, including the ancillary structures, should be considered by a person with an understanding of how that building is likely to behave in an earthquake.

65. Building elements considered to pose a life-safety issue if they fail should only be installed by a suitably qualified and experienced person, or under the supervision of such a person. The Department of Building and Housing should give consideration to the necessary regulatory framework for this.

## Volume 3: Low-damage building technologies

There are building systems emerging that have the ability to reduce the extent of damage sustained by buildings in earthquakes. The general objective of these low-damage technologies is to provide new forms of lateral load resisting structures, where damage is either suppressed or limited to readily replaceable elements.

This Volume describes the evolving forms of low-damage technologies and how they can give a better seismic performance in major earthquakes, along with some limitations and matters of concern. Practical examples of these structural solutions built from concrete, steel and timber have been presented along with the associated benefits, challenges and costs. The Volume also discusses the performance objectives that underpin New Zealand’s current building regulatory regime and how it allows for innovation.

We consider that there is a place for the use of new building techniques in the rebuild of Christchurch and in developments elsewhere. There will be many cases where their use is justified because of better structural performance notwithstanding any increased costs that result.



## Recommendations

---

We recommend that:

66. Research should continue into the development of low-damage technologies.
67. The Department of Building and Housing should work with researchers, engineering design specialists and industry product providers to ensure evidence-based information is easily available to designers and building consent authorities to enable low-damage technologies to proceed more readily through the building consent process as alternative solutions.
68. The Department of Building and Housing should work with researchers, engineering design specialists and industry product providers to progress, over time, the more developed low-damage technologies through to citation in the Building Code as acceptable solutions or verification methods. This may involve further development of existing cited Standards for materials, devices and methods of analysis.
69. The Department of Building and Housing should foster greater communication and knowledge of the development of these low-damage technologies among building owners, designers, building consent authorities, and the public.
70. To prevent or limit the amount of secondary damage, engineers and architects should collaborate to minimise the potential distortion applied to non-structural elements. Particular attention must be paid to prevent the failure of non-structural elements blocking egress routes.

# Section 2: Seismicity

---

The Canterbury earthquake sequence that began on 4 September 2010 was unusual in two respects. First, the intensity of shaking was unusually high and it occurred in a low-to-moderate zone of seismic activity. Second, the faults that ruptured were located close to and, in one case, passed through an urban area that contained an extensive array of instruments for measuring ground shaking.

## 2.1 Introduction

The earthquakes, which had tragic consequences, have yielded many valuable lessons for seismologists and geotechnical and structural engineers around the world. The detailed records of ground shaking are enabling seismologists to gain a unique insight into the mechanics of the types of earthquakes that occurred.

In Christchurch, there is a wide range of building types, from unreinforced masonry buildings to the most modern structures. The buildings are constructed predominantly on deep alluvial soils, but some are founded on rock. Recording and analysing this damage will give major insights into how these structures have performed and how we can improve the earthquake performance of buildings in New Zealand, but the lessons will be relevant worldwide.

These unusual features help to explain the widespread interest in the Canterbury earthquakes.

## 2.2 The Royal Commission's approach

The Terms of Reference defining the scope of the first part of the Inquiry (into the representative sample of buildings) require the Royal Commission to investigate the various aspects of building failure, "having regard ... to the nature and severity of the Canterbury earthquakes". Accordingly, it was necessary for the Royal Commission to develop an understanding of the Canterbury earthquakes and the characteristics of the ground motions they caused.

The Terms of Reference for the second part of the Inquiry require the Royal Commission to consider the adequacy of the current legal and best practice requirements for the design, construction and maintenance of buildings in CBDs in New Zealand,

to address the known risk of earthquakes. That specifically includes the extent to which the knowledge and measurement of seismic events have been used in setting legal and best practice requirements for earthquake risk management in respect to building design, construction and maintenance. These terms require the Royal Commission to understand the nature of the earthquake risk affecting cities throughout New Zealand and the means by which that risk is assessed and accounted for in building design. Further, we are required to make recommendations as to any measures necessary or desirable to prevent or minimise the failure of buildings in New Zealand and to make recommendations on matters that will inform early decision making on rebuilding and repair work that forms part of the recovery from the Canterbury earthquakes.

Taken together, these provisions in the Terms of Reference meant that it was necessary for us to obtain information about the forces that give rise to earthquakes in New Zealand, the faults on which they occur and the predicted frequency of recurrence. It was also necessary to understand the activity rates of faults that ruptured to cause the Canterbury earthquakes and how they contributed to the ongoing risk of earthquakes in the region.

To this end, we sought advice from GNS Science, New Zealand's leading research organisation in the field of seismic hazards. They provided the report "The Canterbury Earthquake Sequence and Implications for Seismic Design Levels" (the GNS Science report), dated July 2011, in collaboration with Professor Jarg Pettinga of the University of Canterbury.<sup>1</sup> The report was published on the Royal Commission's website in August 2011. It formed the basis of the Royal Commission's understanding of the seismicity

of New Zealand in general and Canterbury in particular. The hearing about these issues was held in October 2011, when four of the authors of the report gave evidence that further informed our understanding.<sup>2</sup>

Given the significance of seismicity to the Inquiry, and to ensure that the advice obtained reflected international understanding and best practice, the Royal Commission instructed two peer reviewers to consider the GNS Science report and advise the Royal Commission of their opinions on it. The reviewers were:

- a) Ralph J Archuleta, Professor of Seismology, Department of Earth Science, University of California (Santa Barbara), and
- b) Norman Abrahamson, Adjunct Professor of Civil Engineering, University of California (Berkeley).

Both provided written reviews that were published on the Royal Commission's website and Professor Abrahamson also gave evidence at the hearing. In addition, eight submissions were received and considered by the Royal Commission.

Subsequent to the hearing, we sought further advice in relation to the nature of the Canterbury earthquakes from Dr. Brendon Bradley of the University of Canterbury. GNS Science provided additional advice by summarising the ongoing work and responding to the significant aftershocks that took place on 23 December 2011.

The Royal Commission's understanding, based on the advice and evidence referred to above, is set out in the following discussion.

## 2.3 New Zealand's tectonic setting

The earthquake and volcanic activity experienced in New Zealand results from the interaction between two tectonic plates known as the Pacific Plate and the Australian Plate. The tectonic plates are segments of the earth's crust. The upper brittle part of the crust that hosts most of the earthquakes varies in thickness from 10–50km. The tectonic plates are in a state of continual movement relative to each other. At their edges they pull apart (in “rift” areas), slide past each other laterally (at a “strike-slip” plate boundary) or converge (“subduction” or “collision” areas).<sup>3</sup>

Most of the world's earthquake and volcanic activity occurs along the boundaries of tectonic plates. The Pacific Plate is the largest and fastest-moving major tectonic plate. Its boundary, the Pacific Rim (sometimes referred to as the “ring of fire”), is characterised by both earthquake and volcanic activity.

New Zealand straddles the boundary zone between the Australian and Pacific Plates that are moving in relation to each other at 35–45mm per year. Figure 1 illustrates the tectonic plate setting of New Zealand.

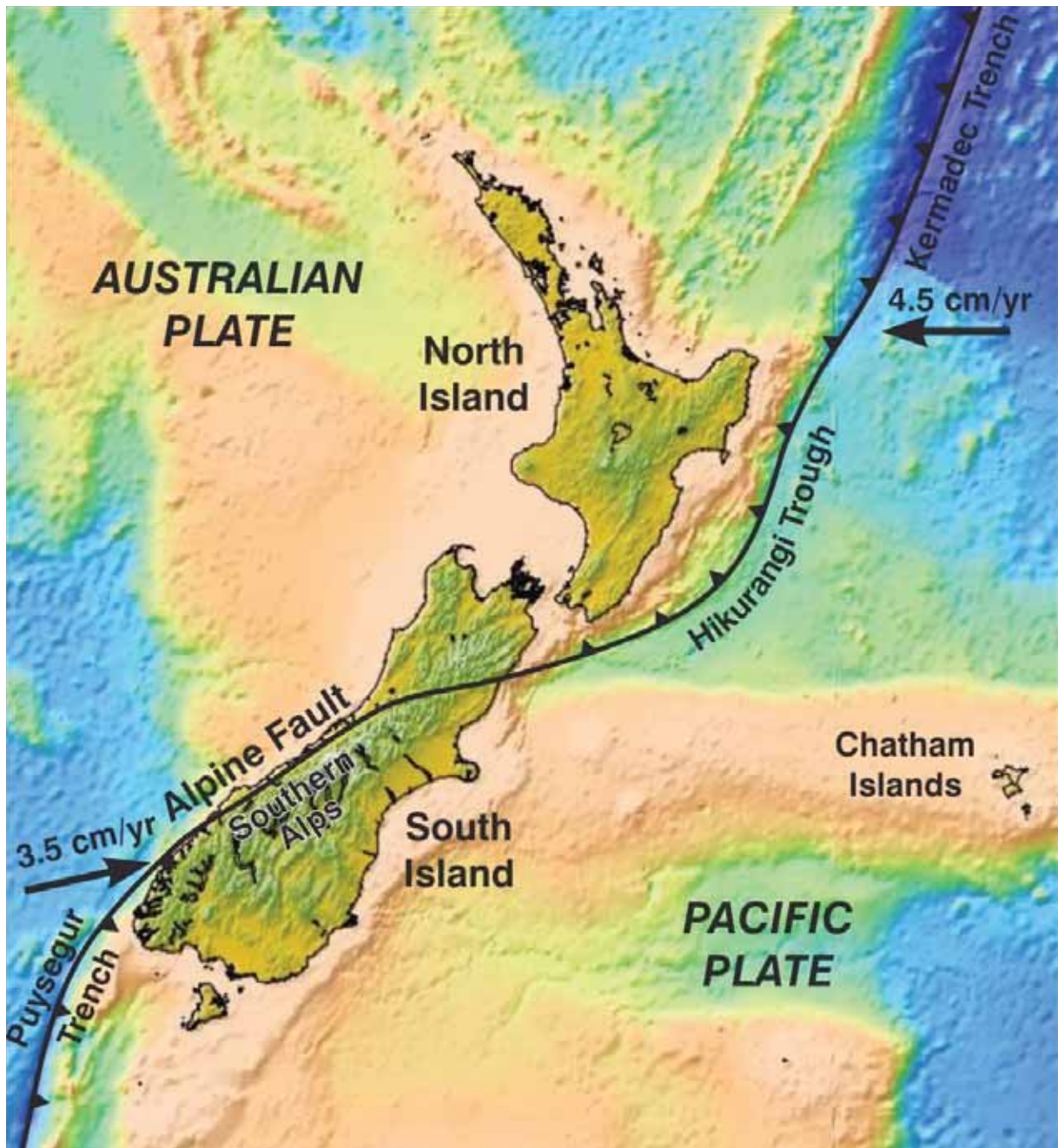

Figure 1: Plate tectonic setting of New Zealand (source: GNS Science report 2011/183, July 2011)

The west-pointing arrow in the upper right corner shows the movement of the Pacific Plate towards the Australian Plate in northern New Zealand, while the arrow pointing north-east in the lower left corner shows the movement of the Australian Plate relative to the Pacific Plate in southern New Zealand.

The plates are in collision in the North Island where the edge of the Pacific Plate “subducts” in a westerly direction under the North Island, offshore of the East Coast along the Hikurangi Trough. Subduction is also occurring off the coast of Fiordland, along the offshore Puysegur Trench where the Australian Plate subducts beneath the Pacific Plate.

In the central and northern parts of the South Island the crusts of the Pacific and Australian Plates are thick. This means that one plate cannot be driven under the other. The plates meet in what GNS Science calls a “glancing collision” and the plate boundary accommodates the movement of rock in the plates in two ways. One is by a sideways slip along the boundary; the other by an upward movement of the edge of the Pacific Plate. As a result of this phenomenon, the west coast of the South Island is moving in a north-easterly direction relative to the rest of the island, at a rate of about 30mm per year. The forced upward movement of the edge of the Pacific Plate has produced the Southern Alps in a process that has lasted millions of years. GPS measurements have been made from the 1990s to the present day; they show that most of the South Island is being continually contorted as it is forced south-west into the Australian Plate.

In the central South Island, about 75 per cent of the motion between the Australian and Pacific Plates occurs during major earthquakes along the Alpine Fault. However, to the east of the Alpine Fault the land is broken into a complex web of active geological faults. It is here that the remaining 25 per cent of plate motion occurs, through occasional earthquakes on these faults. It has been estimated that faults along the eastern foothills of the Southern Alps and within the Southern Alps themselves may accommodate up to 20 per cent of the plate boundary deformation.<sup>4</sup> Similarly, it is estimated that about five per cent of the overall Pacific/Australian Plate motion is accommodated by the fault lines lying beneath the Canterbury plains. The average total movement of these faults is about 1–2mm per year.<sup>5</sup>

GNS Science advises that “it is inevitable that this steady build-up of ground deformation across the Canterbury plains will occasionally be released as earthquakes”.<sup>6</sup>

Satellite surveying over the last 15 years has enabled direct measurement of the deformation (or strain) occurring in New Zealand. This is illustrated in Figure 2, where the dark to red areas have the highest rates of deformation and the orange to yellow shaded areas have the lowest rates.



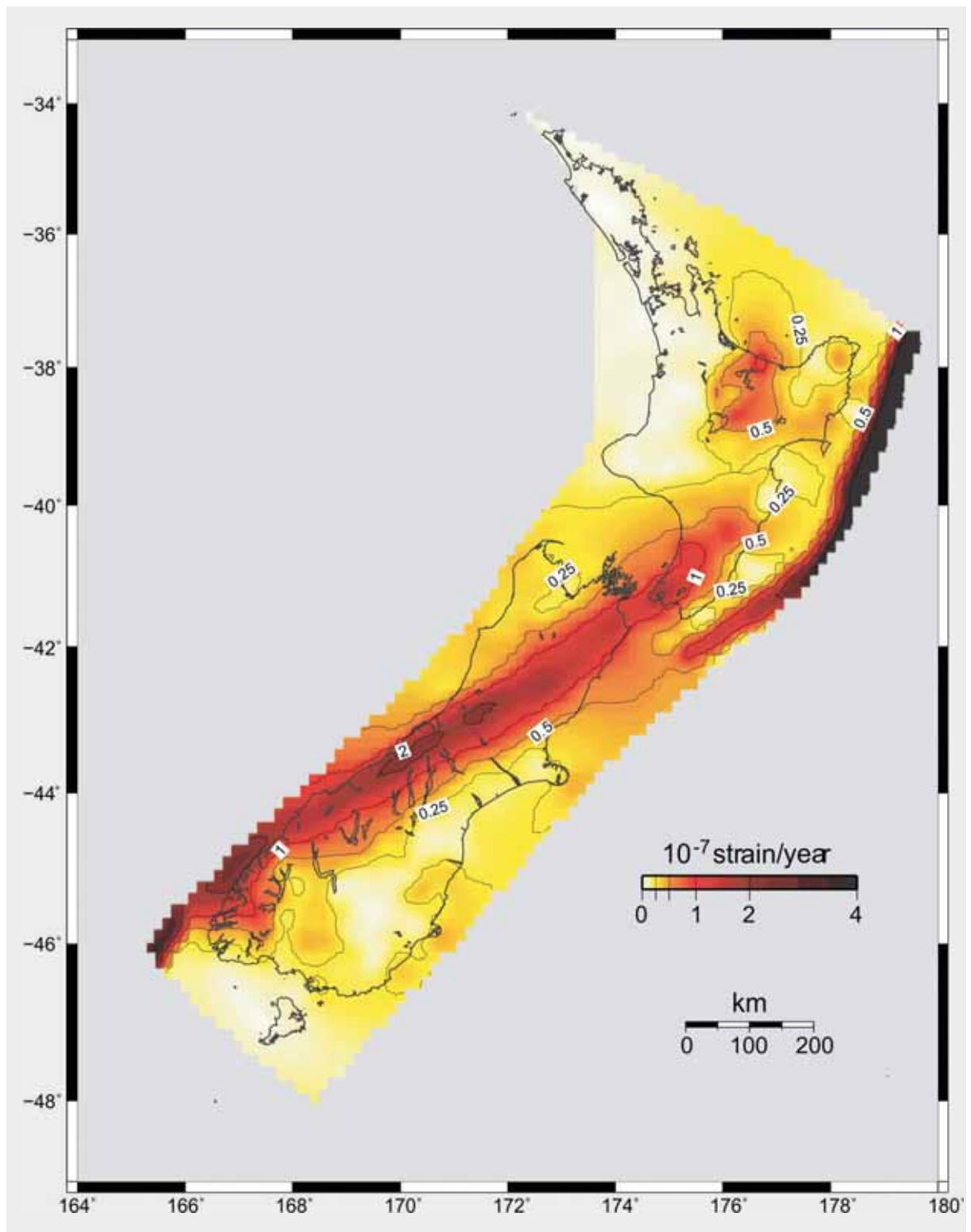

Figure 2: Deformation (strain) occurring in New Zealand (source: GNS Science report 2011/183, July 2011)

Over the last 15 years it has become possible to measure the deformation (strain) occurring in New Zealand directly by satellite surveying using GPS. The dark to red areas have the highest rates of deformation, while the land in the yellow to orange areas is deforming at relatively lower rates. Accumulation of strain in the New Zealand crust will eventually result in earthquakes, so areas with a high strain rate tend to have more earthquakes. Major faults such as the Alpine Fault have extremely high strain rates.

GNS Science observed in its report that the accumulation of strain in the New Zealand crust must eventually result in earthquakes, and those areas sustaining greater strain tend to have more earthquakes. There are extremely high strain rates at the location of major faults such as the Alpine Fault.

## 2.4 Faults

Faults are fractures in rock that result from compression, tension or shearing forces. They are associated with significant movement of the rock on one side of the fault relative to the other, and may be classified based on their orientation and relative movement or slip across the fault plane. Appendix 1 (Definition and Classification of Faults) in the GNS Science report defines and classifies faults on this basis and illustrates the different kinds of fault diagrammatically. This is reproduced as Figure 3 below.

### Definition and classification of faults

**Faults** are rock fractures across which there has been significant movement of the block on one side relative to the other. Faults represent the response of the rock formations to compression, tension or shearing forces. They can be classified on the basis of their orientation and the relative movement or slip across the fault plane (Figure 3).

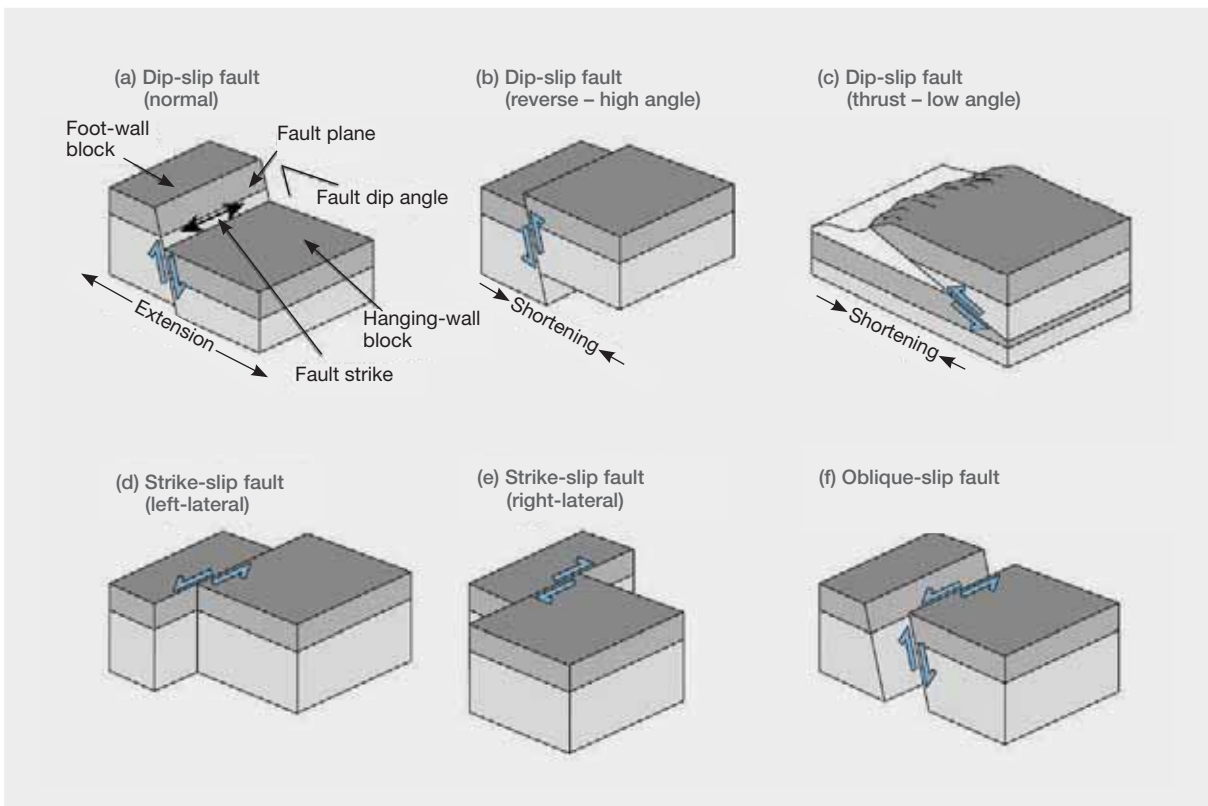

Figure 3: Fault classification and terminology: (a) to (c) dip-slip faulting; (d) and (e) horizontal or strike-slip faults; and (f) oblique-slip faulting. Other fault terminology is shown on block diagram (a). Figure modified from Pettinga et al. (2001)<sup>7</sup>



**Dip-slip faults** are those in which the relative movement of one side to the other is parallel to the direction of the inclination (the dip) of the fault (Figures 3A, 3B, 3C). If the upper block (hanging wall) above the fault plane has moved down the fault plane then the fault is called a *normal fault*, and if the upper block has moved up the fault plane it is called a *reverse fault*. When a fault plane has a shallow angle of slip (less than 45°) and the upper block has moved up the fault plane, it is called a *thrust fault*. Normal faults form in areas where the crust is being pulled apart, while reverse and thrust faults form in areas that are being compressed.

**Strike-slip or lateral faults** are defined by horizontal movement parallel to the line of the fault plane (Figure 3D). Strike-slip faults are often vertical, and movement is described as right-lateral or left-lateral, based on the relative direction of movement of the ground on one side of the fault to the other. *Oblique-slip faults* occur where relative movement across the fault includes both horizontal and vertical slip (Figure 3F).

A **fault trace** is the line where a fault intersects the ground surface and may be recognised by a displacement of ground surface. If one side of the fault rises above the level of the other side, it may form a step-like linear *fault scarp*. Visible fault traces and fault scarps indicate that movement along the fault has been geographically recent.

A **fault strand** is an individual fault of a set of closely spaced, sub-parallel faults, while a fault splay is a subsidiary fault that diverges from a more prominent fault. Fault splays are common near the ends of major faults.

The term **slip rate** is used to refer to the average rate of displacement at a point along a fault. The slip rate is determined from offset geologic features whose age can be estimated. It is measured parallel to the dominant slip direction or estimated from the surveyed vertical or horizontal separation of geological markers in the field.<sup>8</sup>

### 2.4.1 Other terms used to characterise faults

The terms “shallow”, “deep” and “blind” are also used to characterise faults. The first two are reasonably self-explanatory and simply refer to the depth of the fault beneath the surface. The depth of the rupturing fault will be one of the factors that contribute to the felt magnitude of the earthquake. Depending on the nature of the subsurface ground, a rupture that occurs near the surface will be felt more strongly than a rupture having an equivalent energy release and other characteristics seated deeper beneath the surface.

A blind fault is one that has no surface expression and its presence is therefore difficult to identify.

## 2.5 Active faults in the Canterbury region

There are four major types of rock formation in the Canterbury region. The deepest and oldest layer, which underlies the others, is made of hardened sandstones and mudstones, commonly referred to as “greywacke”. Originally the New Zealand land mass was a part of the super continent of Gondwana, from which it split about 85 million years ago. The greywacke had been deposited and deformed before the split occurred. As New Zealand moved away from Gondwana, the land eroded and subsided. In the period 80–25 million years ago, terrestrial and marine sediments were deposited on the eroded surface of the greywacke basement rocks. Subsequently, more marine sediments were deposited and volcanic eruptions resulted in the formation of Banks Peninsula in the period of 11–6 million years ago. During the last two million years, as ice age glaciers advanced and receded on numerous occasions, rivers flowing from the rising Southern Alps buried the underlying rocks of the Canterbury plains under alluvial gravels typically ranging in thickness from 200–600m.

As New Zealand parted from Gondwana its basement rocks were pulled apart. They developed a system of faults that extended through the basement greywacke and into the layers above. They remain beneath both the Canterbury plains and Banks Peninsula today.

There is a summary description of the tectonic structure of the Canterbury region in Appendix 2 of the GNS Science report, which we have reproduced as Annex 1. The summary description of the tectonic structure of the Canterbury region describes eight structural domains shown in Figure 22.

The Alpine Fault runs down the western side of the Southern Alps and is about 650km in length. At the hearing, Professor Pettinga illustrated its location and those of other active faults<sup>10</sup> in the South Island by referring to Figure 4.

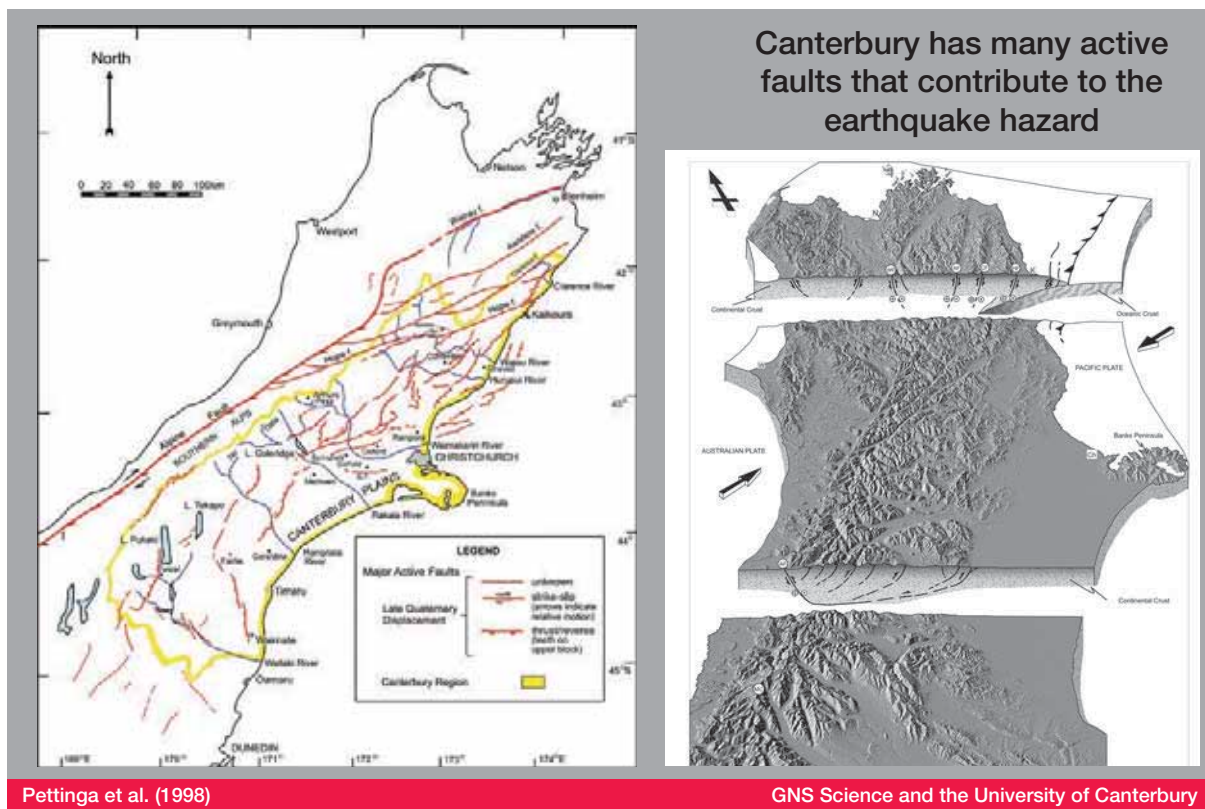

Figure 4: Faulting and the earthquake-driven landscape (source: Evidence to the Royal Commission by Professor Pettinga, University of Canterbury, October 2011)

This figure was prepared in 1998 as part of a regional study for the Canterbury Regional Council and reflected work carried out by the University of Canterbury and others (including GNS Science) in the period since 1987. The study established that there were more than 100 active faults in the Canterbury region capable of generating large earthquakes. Before this, only eight active faults had been documented in the region.

Those faults include the Hope Fault, which is about 220km long and extends from Kaikoura through Hanmer Springs to the West Coast, where it links into the Alpine Fault at a point south-east of Greymouth. It is divided into a series of individual segments, each of which is capable of generating large earthquakes. Another significant fault is in the 40km long (as exposed in the surface) Porter’s Pass-Amberley Fault Zone, which has ruptured at least five times at comparatively regular intervals over the last 10,000 years. In his evidence, Professor Pettinga referred to estimates that the fault is capable of generating earthquakes of up to magnitude 7.5. The GNS Science report and Professor Pettinga also referred to other faults located to the east and south-east of the Porter’s Pass-Amberley Fault Zone, including the Ashley Fault north of Rangiora, the Hororata Fault and the Springbank Fault, all roughly to the north-west of Christchurch.

In his evidence, Professor Pettinga emphasised that:

- the plate boundary zone in the South Island is between 150–200km wide, resulting in earthquake activity in much of the island;
- the nature of the collision of the continental plate crusts in the central part of the Island results in relatively shallow earthquakes, which are typically the most damaging kind; and
- the thickness of the layer of alluvial gravels beneath the surface of the Canterbury Plains means that there are faults whose existence is masked and it is very difficult to ascertain whether or not they are active.

The 4 September and 26 December 2010 (Boxing Day) and 22 February, 13 June and 23 December 2011 earthquakes all occurred on faults that had not previously been known to exist. The GNS Science report commented that because the gravels remained largely undisturbed until the September earthquake,

...it can be inferred that movements along the inherited faults under the Canterbury Plains causing large earthquakes are generally rare and separated in time by long periods of quiescence extending over thousands of years.<sup>11</sup>

The September, Boxing Day and February earthquakes highlighted the fact that there remain significant gaps in the knowledge of the subsurface geology of the region. Professor Pettinga explained the particular challenges that existed in Canterbury because of the thickness of the Canterbury plains' gravel layer and its potential to mask fault activity, leading to a lack of evidence about whether or not the faults were active. In an attempt to increase the extent of knowledge about seismic reflection, several surveys were undertaken in areas that have been associated with very extensive aftershock activity. They included the eastern side of Lyttelton Harbour to the north (encompassing much of the Pegasus Bay area), the area between the Christchurch Central Business District (CBD) and New Brighton Beach, and in the area between the eastern end of the Greendale Fault (that ruptured on 4 September 2010) and the Port Hills Fault (that ruptured on 22 February 2011). A specially designed vehicle under contract from the University of Calgary in Canada was used to carry out the land-based survey work. The survey involved transmitting vibrations into the ground through the different geologic strata and recording the reflected signal by a series of geophone lines (sensors) laid out on and connected to the ground. This information was then captured in a recording system to be analysed later. The surveys targeted the top two kilometres of the subsurface because displacements of strata extending up towards the ground might indicate that there had previously been significant and relatively recent earthquake events. Equipment deployed on a marine survey vessel was used by the National Institute of Water and Atmospheric Research (NIWA) to survey in Pegasus Bay. The vessel towed a long PVC tube containing hydrophones and sent a sound signal down over the stern of the ship. The hydrophones collected the reflected signals coming up from beneath the floor of the sea.

In addition to the seismic reflection surveys, data gathered locating the hypocentres (the hypocentre is the point of origin of the rupture beneath the surface. The epicentre is the point on the surface above the hypocentre) of aftershocks have also contributed to the knowledge about the location and extent of the active faults. The location of part of the Greendale Fault is now visible on the surface. The onshore and offshore investigations carried out since the earthquake sequence began have revealed a number of hidden active faults, based on aftershock patterns and seismic reflection surveys. It is important that such survey work be carried out to increase understanding of the number, location and extent of the active faults. It must be accepted, however, that it is unlikely that currently available investigative techniques would be able to build up a complete picture, as the subsurface conditions militate against that.

Professor Pettinga illustrated the location of known active faults at the time of the hearing in the following figures. The first, Figure 5, shows the known active faults in and near Christchurch as at October 2011. The second, Figure 6, shows the known active faults in Pegasus Bay.

Professor Pettinga concluded that there does not appear to be a single fault extending through the ground beneath Christchurch. Rather, it is now known that there are a number of active faults under and near the city, including the Greendale Fault, the Port Hills Fault and the faults that ruptured on Boxing Day 2010 and 13 June 2011. Since the hearing, there has also been the significant earthquake that occurred on 23 December 2011, with its epicentre about six kilometres off the coast of New Brighton.





## 2.6 Earthquakes

### 2.6.1 Earthquake magnitude

The magnitude of earthquakes has been described by various magnitude scales, of which the most well known is the Richter scale. Other earthquake magnitude scales are calculated after more sophisticated data processing and analysis.

The Richter magnitude (in modified form) is the magnitude often initially reported by GNS Science on the GeoNet website ([www.geonet.org.nz](http://www.geonet.org.nz)) because it can be quickly ascertained using nearby seismographs. This is referred to as the  $M_L$  magnitude in the following extract from the GNS Science report, which also describes the other magnitude measures frequently used.

#### Earthquake magnitude

**$M_L$  ('Richter' magnitude)** is the initial magnitude assigned to an earthquake with routine GeoNet processing. The GeoNet  $M_L$  is a modification of the original magnitude scale defined by C.F. Richter in 1935.  $M_L$  is derived from measurements of the peak amplitude on seismographs and is thus a preliminary estimate of the amount of energy released by the earthquake. It is measured on a logarithmic scale, so each magnitude increment of one represents an order of magnitude increase in the measured amplitude or about 30 times more energy released.

**$M_w$  (Moment magnitude)** is a measure of the final displacement of a fault after an earthquake. It is proportional to the average slip on the fault times the fault area.  $M_w$  is more complicated to determine than  $M_L$ , but is much more accurate, although the standard methods used to determine it are valid only for larger earthquakes ( $\sim M_w > 4.0$ ).  $M_w$  is a rough proxy for the amount of low-frequency energy radiated by an earthquake and is commonly used worldwide to characterise large earthquakes.

**$M_e$  (Energy magnitude)** is a measure of the amount of energy released in an earthquake so it is very useful for determining an earthquake's potential for damage.  $M_e$  is determined from the amplitude of all frequencies of seismic waves as measured on seismographs (as opposed to just the peak amplitude for  $M_L$ ) and thus contains more information about the overall energy released in an earthquake and hence its destructive power. Two earthquakes with identical  $M_w$  (i.e., identical fault area times average slip) can have differing  $M_e$  if the strength of the faults that ruptured is different. Earthquakes on strong faults have relatively high  $M_e$ , whereas those on weak faults have relatively low  $M_e$ .

**Modified Mercalli Intensity** scale is a measure of how ground shaking from an earthquake is perceived by people and how it affects the built environment at a particular location. In any given large earthquake, the Mercalli Intensity will depend on the location of the observer and will usually be greatest nearer to the earthquake's hypocentre. This information is complementary to "static" magnitude estimations ( $M_L$ ,  $M_w$ ,  $M_e$ ) that describe the earthquake source rather than the ground shaking experienced.<sup>13</sup>

Thus, ground shaking as described by Modified Mercalli Intensities is derived from the initial ground acceleration values, felt reports and observed damage.

### 2.6.2 Accelerations

Earthquakes give rise to violent ground motions, which can be measured in terms of their acceleration. Forces generated by earthquake motions are the product of the mass of an object subject to the earthquake and the acceleration to which it is subject. The generally accepted measure for acceleration is to refer to the acceleration produced by the action of gravity. The convention is to use 'g' as the constant for the acceleration due to gravity. Hence accelerations are shown as a proportion of g ( $9.81\text{m/s}^2$ ).

### 2.6.3 Historic earthquakes in New Zealand

Given the tectonic setting outlined above, it is not surprising that New Zealand has a long history of earthquakes, ranging from insignificant minor tremors to violent ground movements. Where the latter have coincided with centres of population, they have caused major damage and significant fatalities.

Figure 7 shows the distribution of earthquakes with a magnitude of 6.5 or greater since 1840 to June 2011.

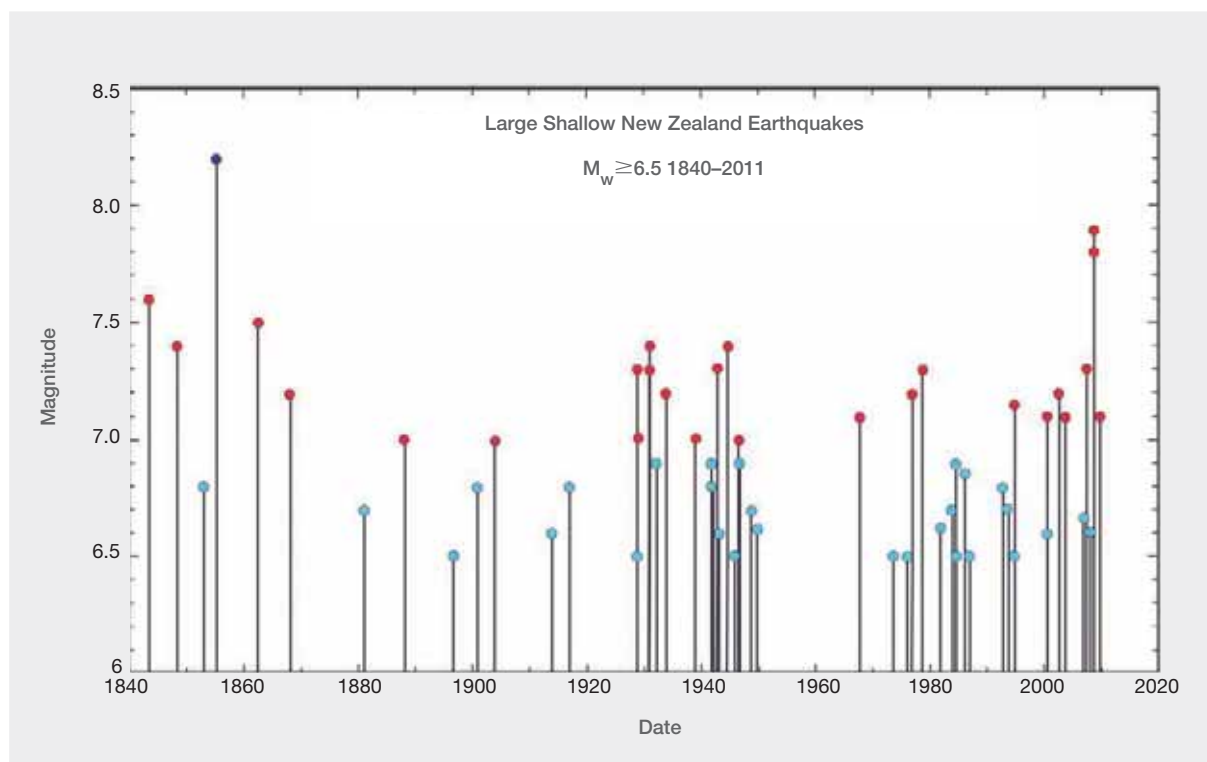

Figure 7: Large shallow New Zealand earthquakes (magnitude 6.5 or greater) (source: GNS Science Consultancy Report 2011/183, July 2011)

The February 2011 earthquake is not represented here, because its magnitude was less than  $M_w$  6.5. Some of the large earthquakes occurred too far offshore to cause any damage on land.

Most of these earthquakes pre-dated modern methods of measurement so the magnitudes of the earthquakes is a matter of inference from physical evidence and eyewitness observations. There are accounts of large earthquakes in Māori oral tradition and between 1840 and 1904 there were at least seven earthquakes of magnitude 7 or greater. New Zealand's most powerful earthquake remains the Wairarapa earthquake of 1855, which had an estimated magnitude of 8.2. There was a relatively quiet period between 1905 and 1928. However, between 1929 and 1942 there was a substantial increase in earthquake activity and, in the three-year period from 1929 to 1931, there were five magnitude 7 earthquakes. These included the Buller (or Murchison) earthquake on 16 June 1929, which resulted in 17 deaths, and the Napier earthquake on 3 February 1931, in which 256 people lost their lives.

The latter half of the twentieth century was comparatively quiet with only a few large-magnitude earthquakes and most were too far offshore to cause much damage. An exception was the magnitude 7 earthquake that struck Inangahua on 24 May 1968, which resulted in three deaths and caused significant property damage.

Since 2000, however, there has been an increase in the number of earthquakes of magnitude 7 or more, although until September 2010 these had all occurred away from population centres, with several in Fiordland.



### 2.6.4 Previous earthquakes in Canterbury

The GNS Science report notes that since organised European settlement of the Canterbury plains began in the mid-nineteenth century, Christchurch has experienced earthquakes causing intermittent damage. Until the present earthquake sequence commenced, most of the damaging earthquakes had occurred as a result of ruptures on more distant faults. However, the two earliest damaging earthquakes, which occurred in 1869 and 1870, had epicentres in the region.

The earthquake of 5 June 1869 was centred beneath the city, probably around the Addington–Spreydon area and is thought to have had a magnitude of 4.7–4.9. The earthquake was shallow, damaging buildings in the CBD and in areas now referred to as Avonside, Linwood, Fendalton and Papanui. Many chimneys fell and there was minor damage to some stone buildings, including the tower of St John’s Church in Latimer Square.

On 31 August 1870 an earthquake with an estimated magnitude of 5.6–5.8 occurred. The earthquake was shallow and had an epicentre near Lake Ellesmere to the south-west of Banks Peninsula. It was felt over a larger area than the 1869 earthquake and caused damage to brick buildings in Temuka. Damage in Christchurch was minor, with fallen chimneys and minor structural damage occurring to a few buildings. The shaking was felt strongly in Lyttelton and Akaroa, and rocks fell from cliffs around Lyttelton Harbour.

The other notable earthquakes in Canterbury occurred as a result of ruptures on faults more distant from Christchurch. They included:

- an earthquake on 5 December 1881 centred in the Torlesse Range–Castle Hill area. It had an estimated magnitude of 6 and caused minor damage to stone and brick buildings in Christchurch. Some parts of the stonework on the spire of Christ Church Cathedral fell during this earthquake;
- an earthquake on 1 September 1888 centred in the Amuri District in North Canterbury. The earthquake had an estimated magnitude of 7.0–7.3. This was a rupture of the Hope Fault, one of the first documented examples in the world of horizontal ground movement along a fault in an earthquake. There was extensive building damage, landslides and liquefaction of river terrace sediments in the Amuri District. In Christchurch, the cathedral lost the top eight metres of its stone spire. There was some damage to other stone buildings and chimneys and minor rock falls occurred around Lyttelton Harbour;
- an earthquake on 16 November 1901 with an estimated magnitude of 6.8 was centred near Cheviot. Most brick and sod buildings in Cheviot collapsed. There were many broken windows in Christchurch buildings, cracked stonework and toppled chimneys. Once again, the spire on Christ Church Cathedral was damaged and lost its top metre and a half. In the town of Kaiapoi, liquefaction affected two or three blocks of the town;
- an earthquake on Christmas Day 1922 with a magnitude of 6.4 and an epicentre near Motunau. Chimneys on buildings between Cheviot and Christchurch were damaged and there was other minor structural damage. On this occasion, the large stone cross on Christ Church Cathedral fell to the ground, breaking some of the slate roof tiles. There is evidence that there was liquefaction at Waikuku and Leithfield beaches;
- a magnitude 7 earthquake on 9 March 1929 occurred along the Poulter Fault in Arthur’s Pass National Park. It resulted in many landslides and the closure of the highway to the West Coast for several months. There was only minor damage in Christchurch, including damage to the northern wall and oriel window of the Provincial Council Chambers;
- a magnitude 7.3 earthquake on 16 June 1929 was centred near Murchison (called the Buller or Murchison earthquake). Damage experienced in Christchurch was minor, affecting a few chimneys and windows; and
- a magnitude 5.2 earthquake on 9 March 1987 was centred in Pegasus Bay about 50km north-east of New Brighton. Some chimneys in North Canterbury were damaged and there was cracked paving in the New Brighton area.



## 2.7 The Canterbury earthquakes

The Royal Commission’s Terms of Reference define the “Canterbury earthquakes” as follows:

**Canterbury earthquakes** means any earthquakes or aftershocks in the Canterbury region—

- (a) on or after 4 September 2010; and
- (b) before or on 22 February 2011.

In our Interim Report, we also dealt with the significant aftershock that occurred on 13 June 2011, which had been addressed in the GNS Science report. It was appropriate to do so (notwithstanding the definition in the Terms of Reference) as the event of 13 June was clearly an important part of the ongoing sequence of aftershocks; we have power under clause (e) of the Terms of Reference to consider “any other matters arising out of, or relating to, the foregoing” that come to our notice and that we consider should be investigated. On the same basis, we have considered the aftershock that occurred on 23 December 2011 and have sought and obtained further advice from GNS Science about that event.

The discussion that follows was largely based on the advice we received in the GNS Science report and from the experts (including Adjunct Professor Abrahamson) who gave evidence at the hearing.

### 2.7.1 The nature of the Canterbury earthquakes

Before discussing the individual earthquakes in the sequence, we give this introductory overview.

The key aspects of the major events in the sequence are given in Table 1 and set out in section 2.7.1.6 of this Volume. A series of aftershocks accompanied each major event.

The initial earthquake on 4 September 2010 had a magnitude of  $7.1M_w$ . The next significant earthquake occurred on Boxing Day 2010. This was significant because, although its magnitude was significantly lower, at  $4.7M_w$ , its epicentre was within the CBD and because of its shallow depth it caused some local structural damage. A major aftershock followed some five and a half months after the September earthquake, on 22 February 2011, when the Port Hills Fault ruptured. This earthquake had a magnitude of  $6.2M_w$ . The rupture was on a different fault. The epicentre of this event was 42km from that of the September earthquake. Almost four months later, on 13 June 2011, there was another significant earthquake of magnitude 6 and, after an interval of over six months, a magnitude 5.9 earthquake followed on 23 December 2011.

As shown in Table 1 (on page 36), the measured peak ground accelerations (PGAs) in these earthquakes were all high. The previous maximum ground acceleration measured in New Zealand was 0.6g in the Inangahua earthquake of 1968. As the table shows, the peak ground accelerations measured were, in several instances, two to three times as high. Figures 8, 9, 10 and 11 show the peak ground accelerations for the September, Boxing Day, February and June earthquakes respectively.

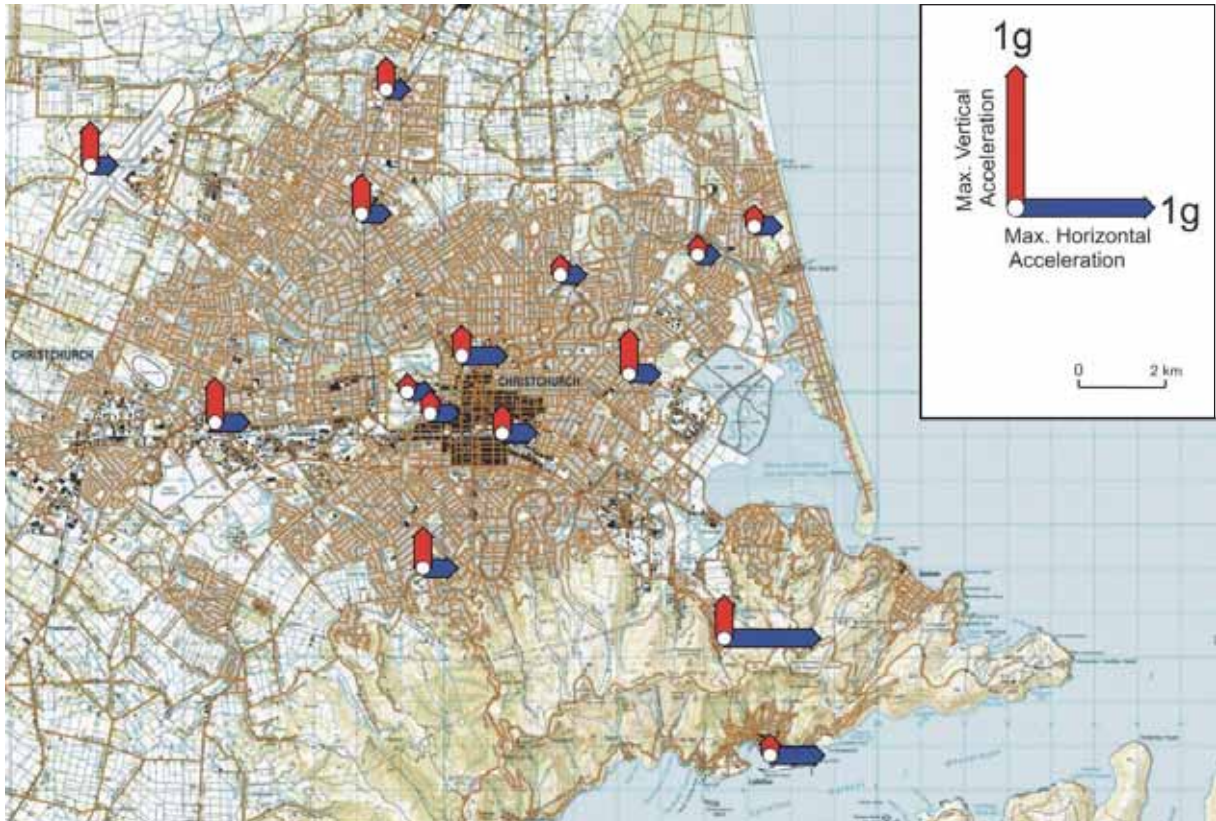

Figure 8: Maximum horizontal and vertical peak ground accelerations during the 4 September 2010 earthquake at GeoNet stations and using temporary accelerometers (source: GNS Science report 2011/183, July 2011)

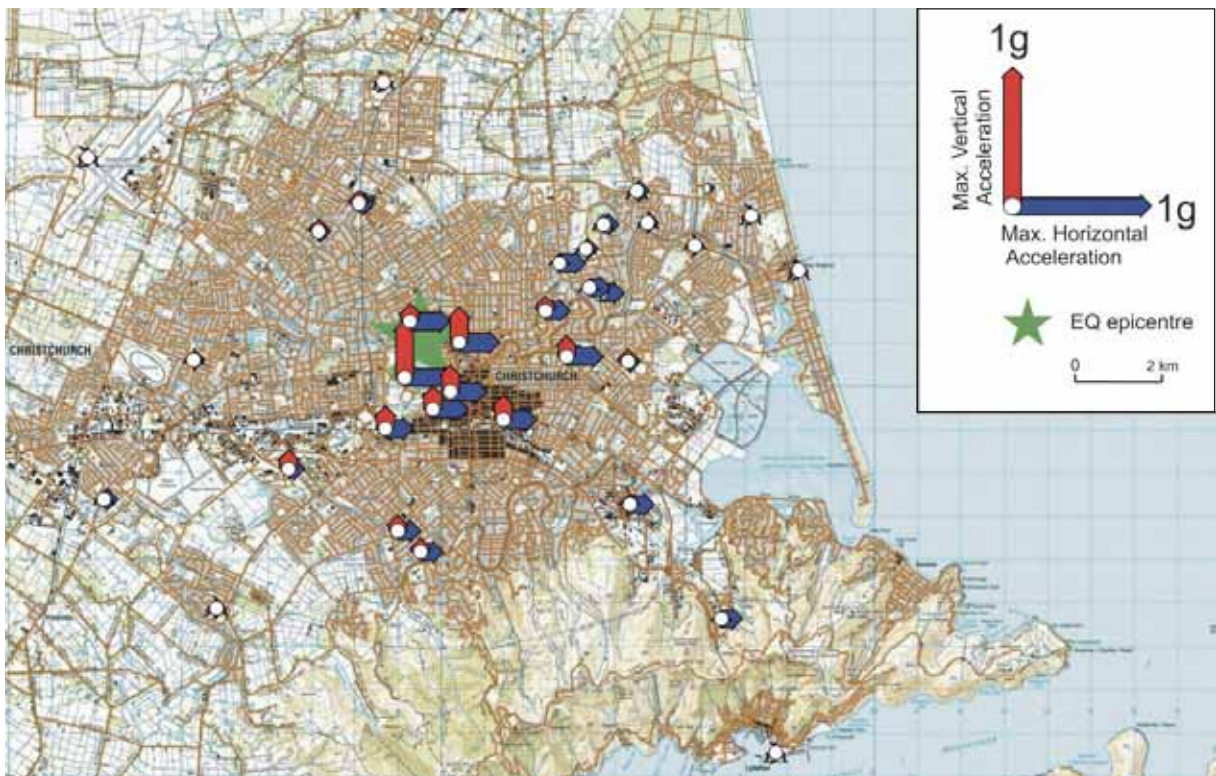

Figure 9: Maximum horizontal and vertical peak ground accelerations during the Boxing Day 2010 earthquake at GeoNet stations and using temporary accelerometers (source: GNS Science report 2011/183, July 2011)



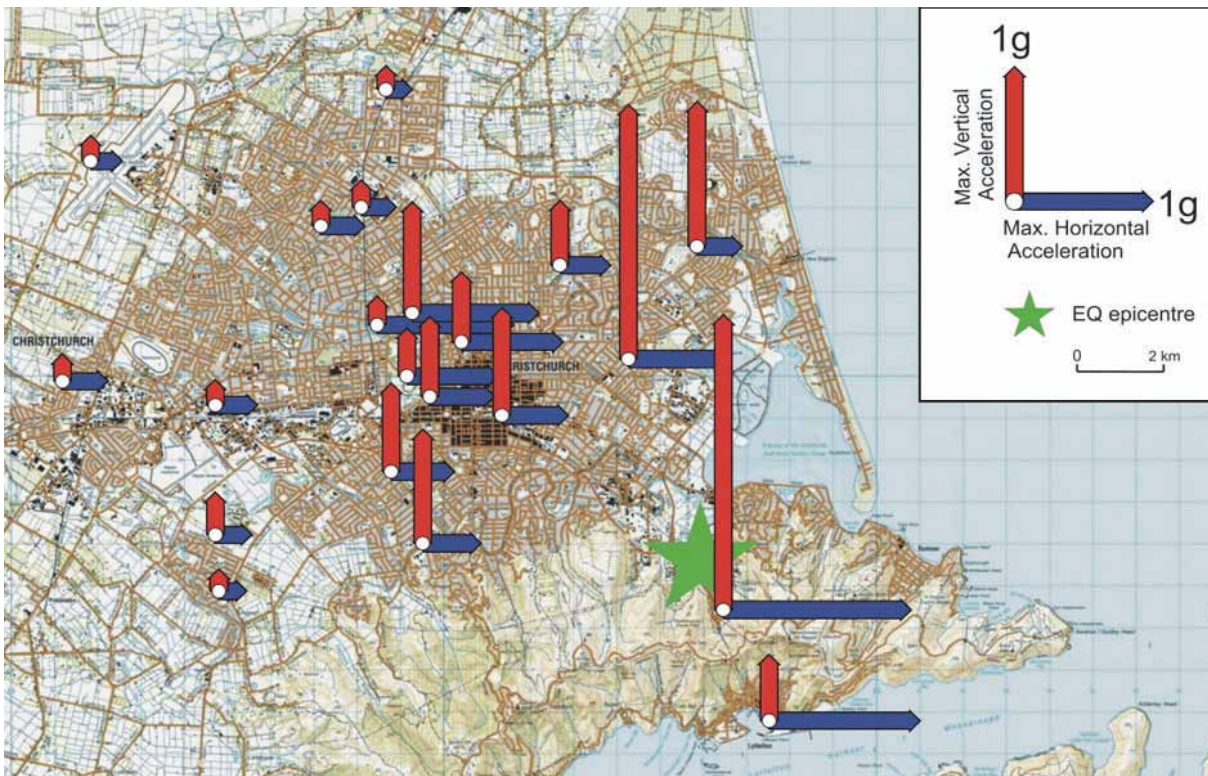

Figure 10: Maximum horizontal and vertical peak ground accelerations during the 22 February 2011 earthquake at GeoNet stations and using temporary accelerometers (source: GNS Science report 2011/183, July 2011)

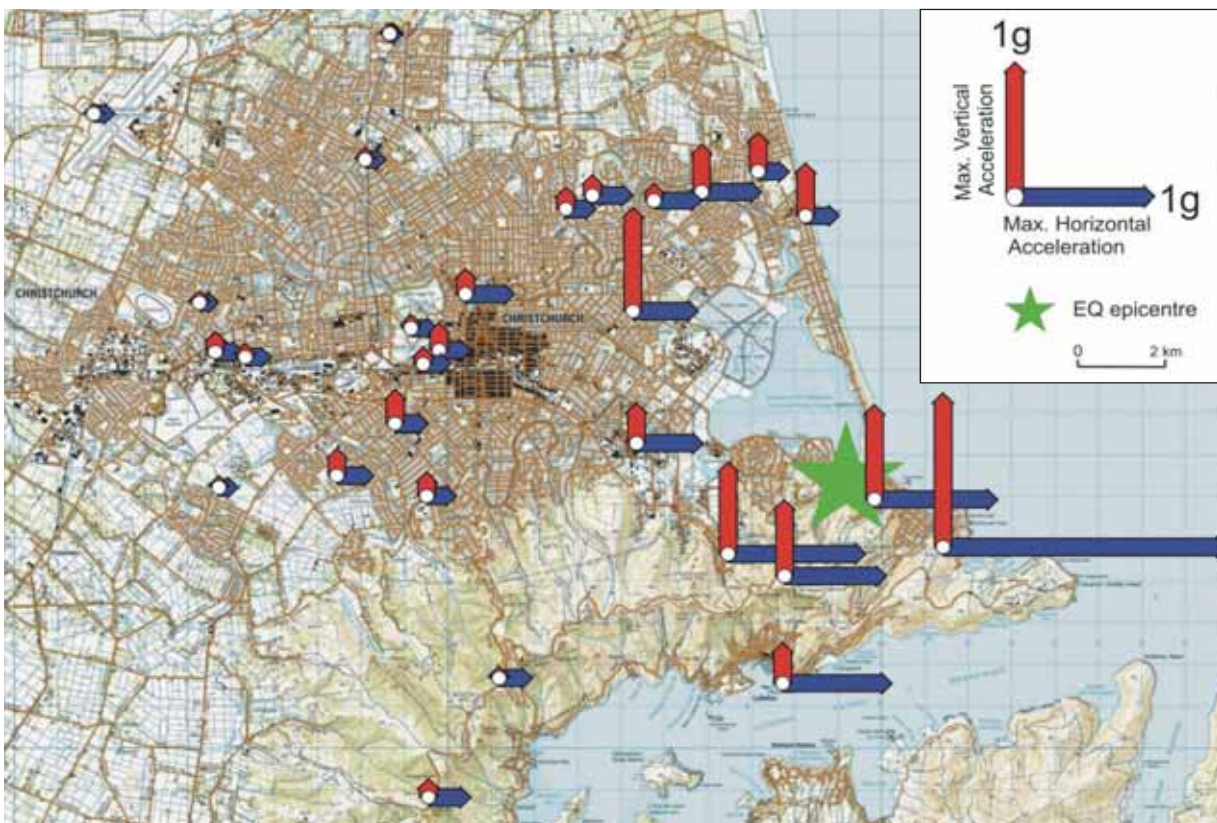

Figure 11: Maximum horizontal and vertical peak ground accelerations during the 13 June 2011 earthquake at GeoNet stations and using temporary accelerometers (source: GNS Science report 2011/183, July 2011)

The significance of the distance from the fault on these ground motions can be seen from response spectra derived from the earthquake ground motions. Design response spectra are used by structural and geotechnical engineers to determine the forces and displacements for which structures should be detailed to sustain to ensure they will perform satisfactorily in a major earthquake. Comparing the design response spectra with spectra obtained from the measured ground motions enables the relative severity of the earthquake to be assessed.

Figure 12 compares the response spectra measured at different distances from the fault with current design spectra for Type D soils for the September and February earthquakes. Two design spectra are given, one for a 500-year return period earthquake, which is the spectrum used in the design of most commercial buildings, and the other for a 2500-year return period earthquake, which is used for special structures required for use during a state of emergency.

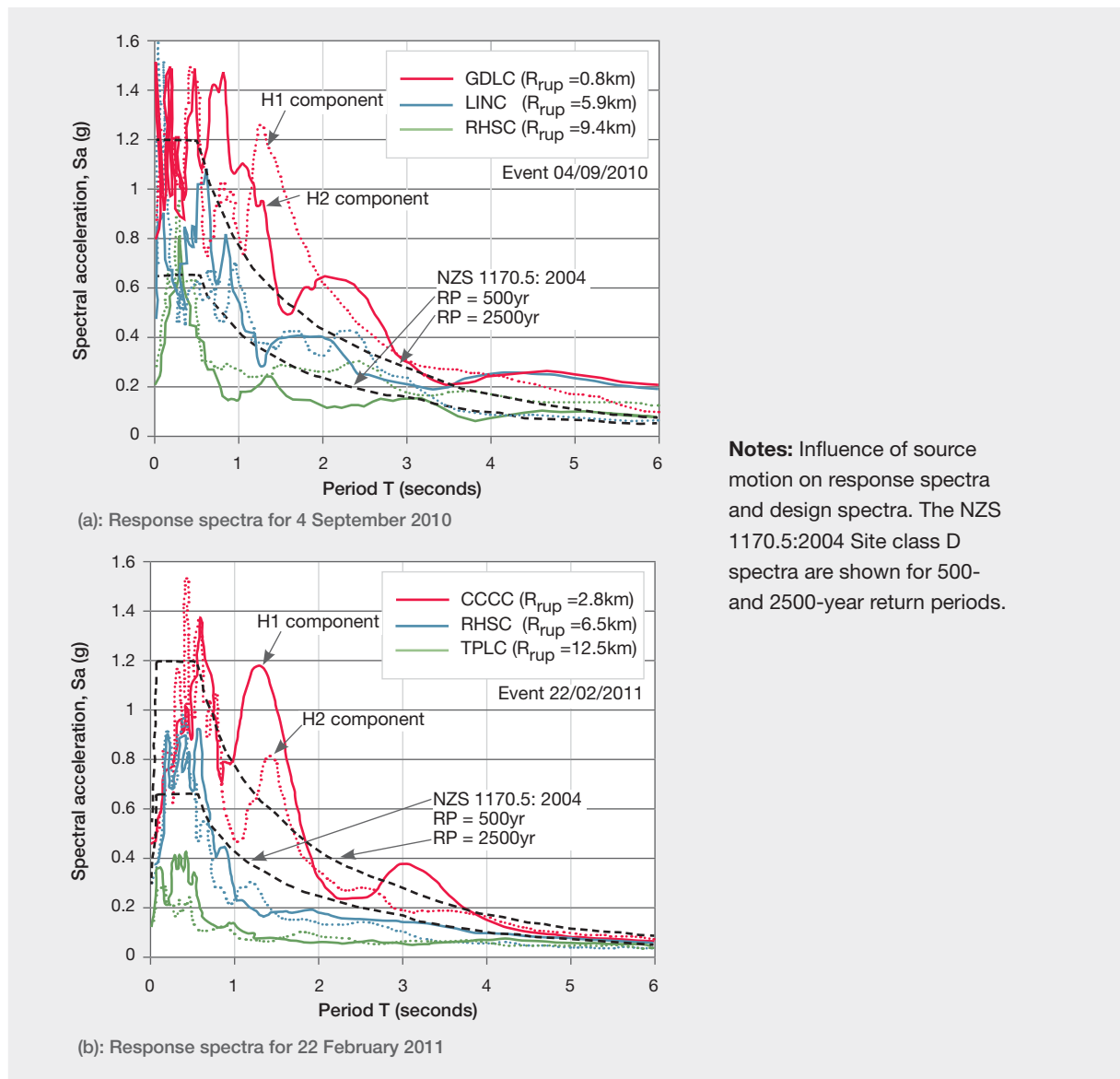

Figure 12: Response spectra for different distances from the faults for the September and February earthquakes (source: Bradley, January 2012)<sup>14</sup>



At each site, the ground motion is recorded in the vertical direction and in two horizontal directions, H1 and H2, at right angles to each other. Figures 8–12 show that the very high seismic forces were confined to regions very close to the fault.

The five per cent damped spectra calculated from these ground motions are shown in Figures 12(a) and (b). The distances of the recording stations from the faults are shown as the  $R_{rup}$  values on the figures.

### 2.7.1.1 The September earthquake

On 4 September 2010, at 4:35am, an earthquake of  $7.1M_w$  struck Christchurch and the surrounding Canterbury region. Its epicentre was about 40km west of Christchurch, on a previously unknown fault beneath the Canterbury Plains. GNS Science advised in its report that this was a rare event that had occurred in an area where previous seismic activity was relatively low for New Zealand.

A number of estimates have been made for the return period of this earthquake, from 8000 years upwards. The 8000-year figure is a minimum period from the

previous earthquake on this fault. GNS Science advises that this figure is likely to be conservative. The value was determined by examining disturbance in the layers deposited by rivers on the plains since the last ice age.

The earthquake caused extensive damage to unreinforced masonry buildings and to old stone buildings of heritage value in Christchurch and the surrounding region. In the eastern suburbs of Christchurch and in Kaiapoi there was significant liquefaction, with silt oozing to the surface and lateral spreading of the land causing damage to houses and infrastructure. The fault left a well-defined surface rupture along what is now known as the Greendale Fault, a fault not previously known to exist.

It was the first earthquake to produce a ground-surface rupture in New Zealand since the 1987  $M_w$  6.5 earthquake at Edgecumbe in the North Island. At its eastern end, the Greendale Fault is covered by more recent alluvial gravel deposited on the Canterbury plains. The surface rupture extended for about 29.5km across farmland to the west of Christchurch. It is represented by the red line in Figure 13.

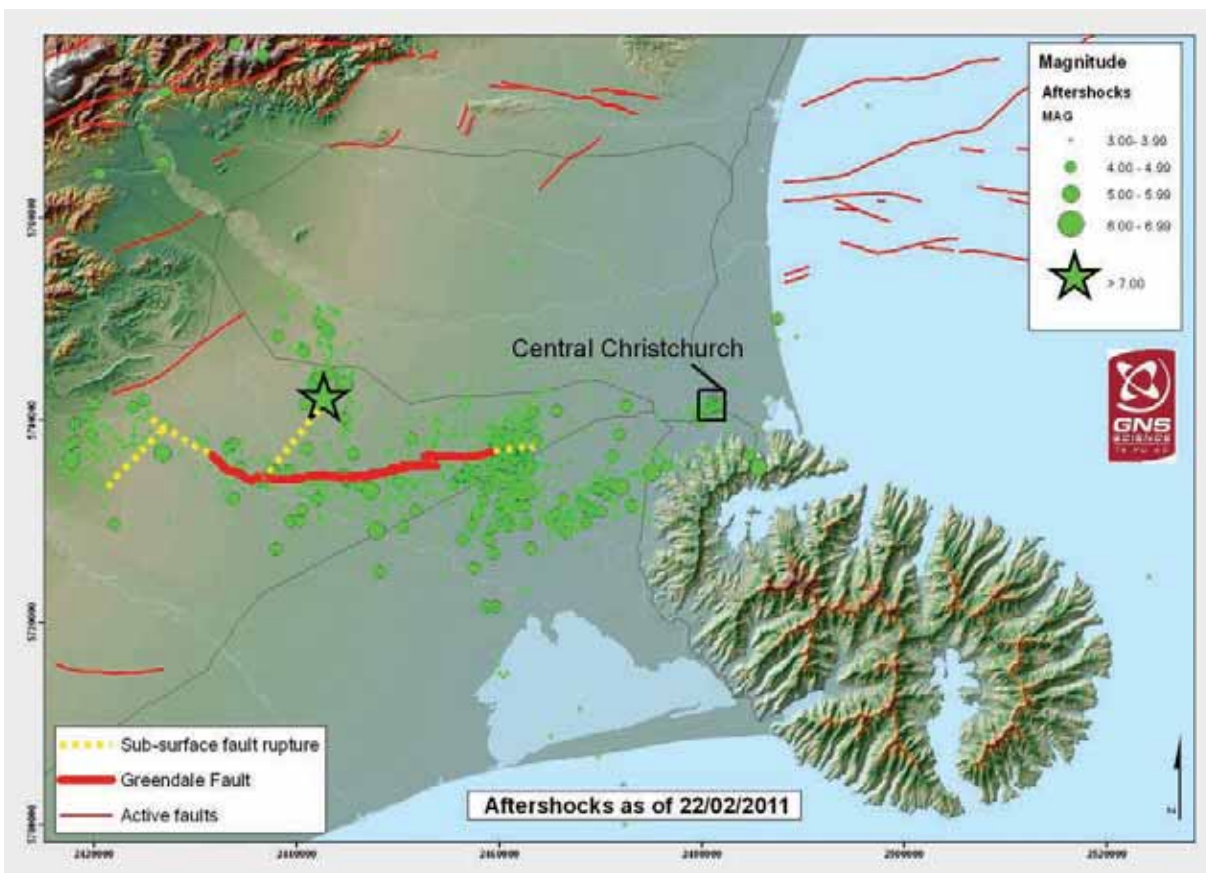

Figure 13: Earthquakes of the Canterbury sequence through to 21 February 2011 (source: GNS Science report 2011/183, July 2011)

The figure shows the faults that ruptured in the September earthquake (as well as the locations of subsequent aftershocks up until 21 February 2011). The green star indicates the point at which it is thought the main shock rupture originated.

The GNS Science report stated that movement on the Greendale Fault was predominantly right-lateral strike-slip with an average horizontal displacement of about 2.5m and a maximum displacement of 5m horizontally and 1.5m vertically. The rupture was not in a continuous line. There was a series of offset fault traces up to 1km apart. It is estimated that the rupture recurrence interval for the Greendale Fault is at least 8000 years.<sup>15</sup>

It is thought that the rupture did not initiate on the Greendale Fault but on another blind fault that intersects with it and is now known as the Charing Cross Fault. After that fault ruptured, the rupture spread to the Greendale Fault and then in both directions along that fault but mainly to the east. There was another smaller thrust fault that intersected with the Greendale Fault at its western end, which probably ruptured later in the earthquake.

Analysis since the 4 September 2010 earthquake suggests that the dominant fault displacements responsible for generating it were very shallow and confined within the upper seven to eight kilometres of the crust.

The rupture on the Greendale Fault was predominantly towards the centre of Christchurch. With this direction of rupture, the shock waves released at the start of the earthquake were reinforced by the shock waves released further along the fault and closer to the city. This increased the intensity of shaking in the direction of Christchurch and reduced it in the other direction. This “directivity” of the earthquake shaking also had the effect of reducing the duration of the strong shaking in the direction of Christchurch and increasing it in the opposite direction. As noted in Table 1, the duration of strong shaking in Christchurch was about 8–15 seconds.

Peak ground accelerations caused by this earthquake reached 1.26g at the Greendale seismic station and were up to 0.3g in central Christchurch. Accelerations measured at various locations in and near Christchurch are shown in Figure 8.

GNS Science advised that peak ground accelerations recorded close to the source were greatest in the vertical direction, while horizontal ground motions were dominant at greater distances away from the

source. In central Christchurch they were close to those that would have been used for building design under the current Earthquake Actions Standard, NZS 1170.5 (although exceeding the Standard's requirements in the vicinity of the rupture). Further, the horizontal ground accelerations at the 1.0s period were generally comparable to those predicted for deep or very soft soils (Class D soils in NZS 1170.5) in the ground motion attenuation model used in the National Seismic Hazard Model (NSHM) discussed in section 2.8. Some variations observed in the CBD are likely to be attributable to complex wave interactions due to basin effects and soil characteristics. It can be said, with some qualification, that the shaking was generally comparable with that anticipated for a design 500-year return period earthquake for Christchurch, although the duration of the strong ground motion was comparatively short. The qualification is that the acceleration response spectrum is on the low side for buildings with a period range of 0–0.25 seconds, and high for a period of 2–4.5 seconds.

### 2.7.1.2 The Boxing Day earthquake

There was a series of shallow aftershocks on 26 December 2010 which GNS Science refers to as the “Boxing Day sequence”. The sequence began with a  $M_W$  4.7 earthquake at 10:30am, and this was followed by magnitude ( $M_L$ ) 4.6 and 4.7 events on that day (note that GNS has not attributed  $M_W$  magnitude to the latter events). In the following weeks, more than 30 aftershocks occurred, closely clustered around the epicentre of the initial event. The initial earthquake was the most damaging. Although it was of short duration, it caused significant damage in the CBD. We refer to it as the Boxing Day earthquake in the discussion that follows.

The Boxing Day earthquake was located at a depth of about 4km, with an epicentre 1.8km north-west of Christ Church Cathedral. Most of the aftershocks associated with this earthquake occurred at depths of 3.5–7km and in close proximity, having epicentres within an area measuring less than one square kilometre. The GNS Science report stated that the earthquakes involved a right-lateral strike-slip movement and their distribution was consistent with an approximately east–west fault plane striking at about 74° east of north and dipping steeply.

Figure 9 shows the maximum horizontal and vertical peak ground accelerations recorded in the Boxing Day earthquake at the GeoNet stations and at temporary accelerometers that had been installed.

The maximum peak ground acceleration of 0.4g was measured at the Christchurch Botanic Gardens. While “felt” reports indicated strong ground motions, the smaller magnitude of the event meant that these motions were confined to central Christchurch. Directivity effects were not significant for this earthquake.

### 2.7.1.3 The February earthquake

The most destructive of the earthquakes occurred at 12:51pm on 22 February 2011 on what is now known as the Port Hills Fault. Of magnitude 6.2, the rupture occurred on a northeast–southwest oriented fault at a shallow depth, reaching to within one kilometre of the surface. This led to the catastrophic collapse of two large buildings in the CBD, the Canterbury Television (CTV) building and the Pyne Gould Corporation (PGC) building, and caused the partial collapse and serious damage of many others. The official death toll now stands at 185 and numerous people were injured. There was widespread liquefaction, especially in Christchurch’s eastern suburbs.

The existence of this fault was unknown before the February earthquake, but there had been some aftershock activity in this area prior to the 22 February event. As the fault has no surface expression, it is very difficult to determine a return period. However, there is evidence to indicate that no significant earthquake had occurred on this fault (or the fault that ruptured on 13 June 2011) within the last 8000 years. The evidence comes from rock falls in the Redcliffs and Sumner area, where the cliffs formed when the sea level was higher. Both the February and June earthquakes generated large rock falls from these cliffs. The absence of evidence of previous falls indicates that there was no major earthquake involving these faults during the previous 8000 years.

GNS Science advised that the faulting movement in this event was also complex, with overall oblique–reverse (a combination of right-lateral strike-slip and thrust faulting) displacements. The rupture produced a maximum slip of 2.5–4.0 metres at a depth of 4–5km on a fault plane dipping by about 70°. GNS Science stated that the main rupture may have been accompanied by a smaller strike-slip rupture on a smaller fault to the south-west beneath the Port Hills and orientated east-northeast to west-southwest.

The resulting ground motions were extremely high. Vertical accelerations reached 2.2g, with horizontal accelerations of 1.7g in the Heathcote Valley near the epicentre and up to 0.8g in the CBD. Both horizontal and vertical accelerations are important for the performance of structures.

Close to the Port Hills Fault, and within a distance of five kilometres, peak horizontal accelerations were stronger than in the September event. At greater distances, peak horizontal accelerations were higher in the September earthquake than at comparable distances in the February earthquake.

GNS Science also compared the earthquake response spectra (there is a discussion of this concept in section 3 of this Volume) of recorded horizontal ground motions at the four measurement sites maintained by GeoNet in central Christchurch, with spectra from the current Earthquake Actions Standard used in building design, NZS 1170.5.<sup>16</sup> This comparison showed that the recorded response spectra exceeded the 2500-year recurrence interval spectra, especially for longer periods, being a little lower for shorter periods of about 0.3 seconds or less. The results of this comparison are shown in Figure 14.



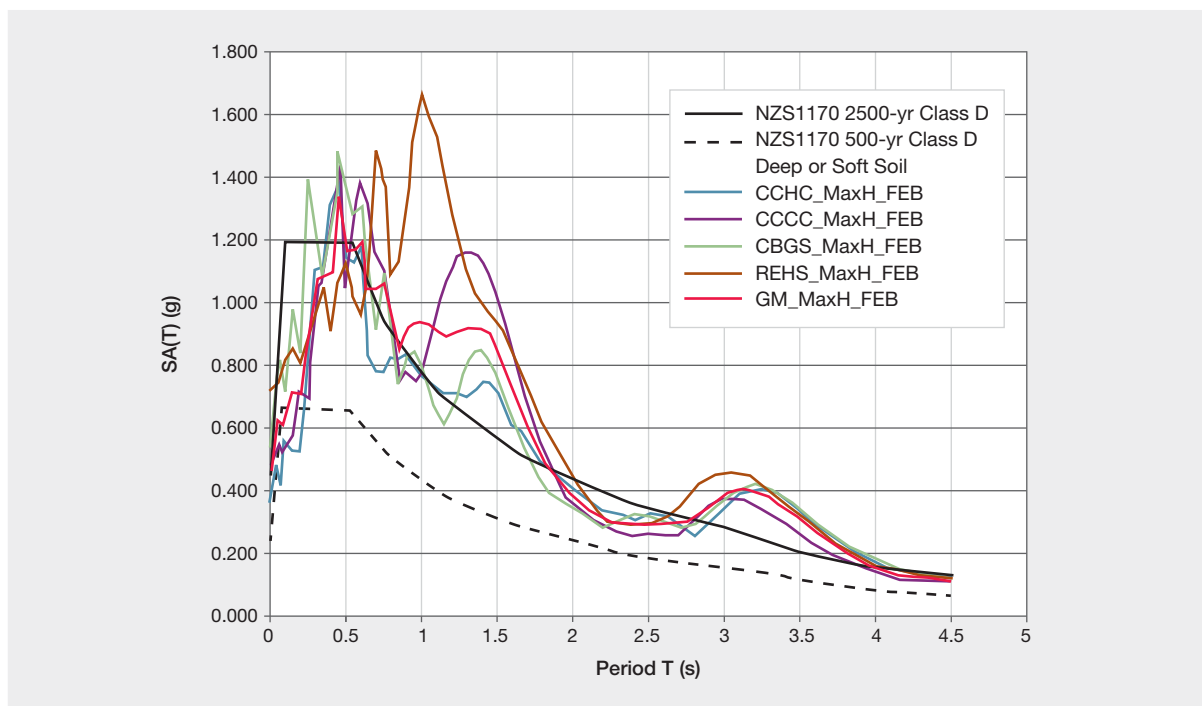

Figure 14: Comparison of recorded response spectra in Christchurch and the design spectra in NZS 1170.5 for deep or soft soil sites (source: GNS Science report 2011/183, July 2011)

The high accelerations experienced in central Christchurch because of the February earthquake may be attributed to the shallowness of the rupture and its proximity to the city. Basin and topographical effects and the high water table are likely to have added to the force of the earthquake. These have contributed to the high vertical accelerations observed, which were greater than the horizontal accelerations nearer the epicentre. The GNS Science report notes that complex wave interactions due to the shape of the basin and deep soils below Christchurch are likely to have caused the peaks observed in ground acceleration over longer periods.

#### 2.7.1.4 The 13 June 2011 earthquake

The epicentre of the earthquake that occurred on 13 June 2011 was close to the suburb of Sumner. There were in fact two significant earthquakes on that day, one of magnitude 6 at 2:20pm that had been preceded by another of magnitude 5.7 a little over an hour earlier. The following discussion focuses on the later and stronger earthquake.

GNS Science has advised that the June earthquake followed the rupture of a right-lateral strike-slip fault, orientated in a north north-west to south-southeast direction. The earthquake was felt strongly in the southern and eastern suburbs of Christchurch (where there was widespread liquefaction) but it also caused damage to vulnerable structures in the CBD, and further cliff collapses and rock falls on slopes in the southern Port Hills.

Peak ground accelerations were again high, with horizontal shaking reaching 2g in Sumner and 0.4g in the CBD. The accelerations are shown in Figure 11.

It can be seen that horizontal peak ground accelerations were dominant. The extremely high accelerations at the Sumner station, which sits on rock, is likely to be the result of the strike-slip nature of the rupture and a degree of amplification of the seismic waves due to the shape of the surface topography.

### 2.7.1.5 The 23 December 2011 earthquake

An earthquake of magnitude 5.8 struck at 1:58pm on 23 December 2011. It was centred six kilometres off the coast of New Brighton and caused liquefaction in the eastern suburbs of Christchurch. There were a number of aftershocks later that day and overnight, several of which were magnitude 5 or greater. They included a magnitude 5.9 event at 3:18pm that day. The sequence was located east of the 13 June sequence of aftershocks and was not characterised by the very high ground motions of earlier events, apart from one isolated high recording at Brighton Beach in the initial aftershock. GNS Science considers this is likely to be explained as a local site effect.

The lower energy magnitudes meant that these earthquakes were not as damaging as the other earthquakes that have been discussed previously.

### 2.7.1.6 Comparisons of the earthquake characteristics

The GNS Science report summarised the main features of the four earthquakes discussed in the report in Table 1.

Table 1: Summary of the main features of the significant earthquakes in the Canterbury sequence (source: GNS Science report 2011/183, July 2011)

Earthquake		Sep 4 2010	Dec 26 2010	Feb 22 2011	June 13 2011	Dec 23 2011	Dec 23 2011
<b>Magnitude</b>	M <sub>w</sub>	7.1	4.7	6.2	6.0	5.8	5.9
	M <sub>L</sub>	7.1	4.9	6.3	6.3	5.85	6.0
	M <sub>e</sub>	8.0	Not known	6.75	6.7	5.6	6.0
<b>Source fault</b>	Rupture	Complex	Strike-slip	Oblique-reverse	Oblique-reverse	Oblique-reverse	Oblique-reverse
	Orientation	E-W surface rupture	E-W	NE-SW	NE-SW N-S	NE-SW	NE-SW
<b>Max. PGA recorded</b>	Horiz. (g)	0.8	0.4	1.7	2.0	0.4	0.7
	Vert. (g)	1.3	0.5	2.2	1.1	1.0	0.4
	Dist. (km)	1.3	~2*	2	3	13* Horiz. 6* Vert.	8* Horiz. 6* Vert.
<b>Max. PGA recorded in CBD</b>	Horiz. (g)	0.3	0.4	0.7	0.4	0.3	0.4
	Vert. (g)	0.2	0.4	0.8	0.2	0.2	0.2
	Dist. (km)	20–22	~ 2–3*	5–9	9–10	13–15*	10–12*
<b>Duration of shaking &gt;0.1g in CBD(s)</b>		8–15	1–1.7	8–10	6–7.5	2–4	3–4

Distances are the distance from the fault trace, where available, but those marked with an asterisk are taken from the earthquake hypocentre. The duration is defined by the approximate length of record containing accelerations over 0.1g.

The sequence included a mixture of strike-slip and reverse faulting at shallow depths on previously unidentified faults at varying distances from the Christchurch CBD. The three largest events had high energy magnitudes ( $M_e$ ) compared to their moment magnitude ( $M_w$ ), which resulted in the radiation of above-average amounts of seismic energy. This led GNS Science to infer that the earthquakes had high stress drops, meaning that the rupture plane area was relatively small for the energy released, implying that the faults were very strong. Professor Abrahamson, in his peer review of the GNS Science report, expressed doubts about GNS Science's conclusion that the earthquakes were high stress drop events, although Professor Archuleta appeared to accept the GNS approach. GNS Science advises that this matter is the subject of ongoing consideration and research in conjunction with experts from the United States and Europe.

Figure 15 compares the response spectra in the Christchurch CBD during the four earthquakes. Each coloured line is an average of the strongest responses calculated from the horizontal ground motions recorded at the four sites in the CBD.

This graph shows that the damage potential for buildings with response periods in the range of 0.1–0.3 seconds (such as houses and other low-rise buildings) would be, in descending order, 22 February, 26 December, 4 September and 13 June. For buildings of four to 10 storeys, with periods typically in the range of 0.4–1.5 seconds, the 22 February event was likely to be significantly more damaging, followed by the 4 September and 13 June events, with 26 December significantly less serious. For high-rise buildings with a response period in the range of 2–3.5 seconds, the February, September and June events would have had a similar damage potential. The Boxing Day earthquake had little potential to cause damage to buildings of more than five storeys.

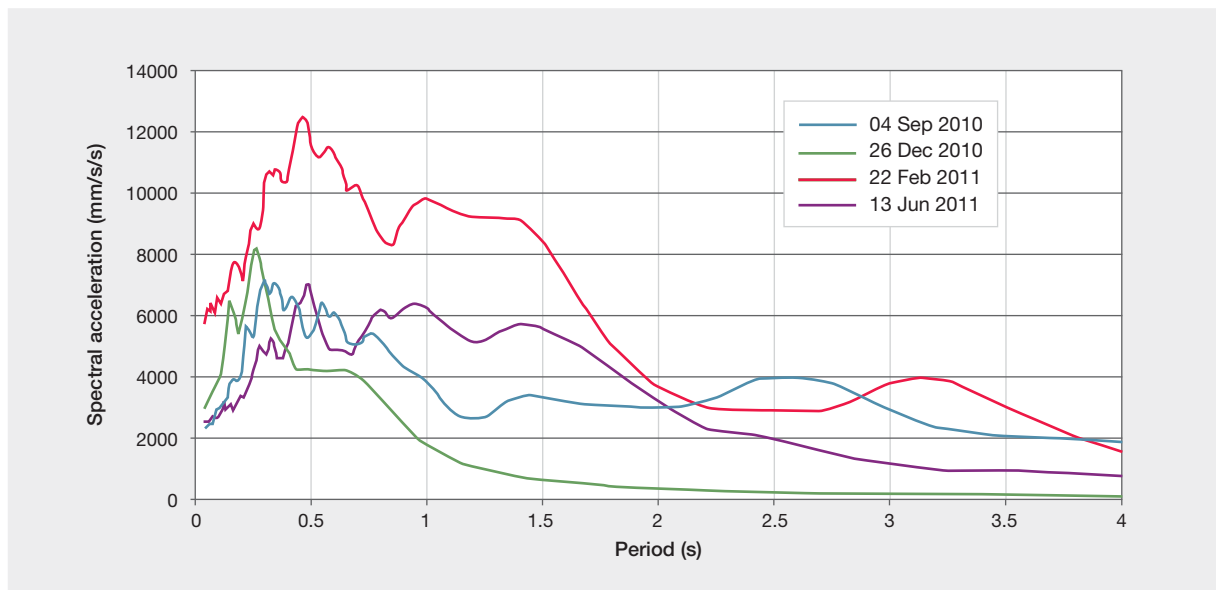

Figure 15: Peak response-spectral accelerations averaged over the CBD recording sites (source: GNS Science report 2011/183, July 2011)

### 2.7.1.7 Comparison with a rupture of the Alpine Fault

The Alpine Fault is a major geological feature and a potential source of major earthquakes in the South Island of New Zealand. The average return period of ruptures on the fault is 260–400 years. GNS Science advises that no major event has occurred on the fault in the last 295 years and there is an assessed 30 per cent likelihood of rupture within the next 50 years. It has also been estimated that an Alpine Fault event could be of magnitude 8 or greater.<sup>17</sup> At its closest, the Alpine Fault is 125km from Christchurch.

For the purposes of advising the Royal Commission on the implications for Christchurch of a rupture on the Alpine Fault, GNS Science estimated ground motions in Christchurch from a magnitude 8.2 event with the rupture propagating from south to north. The modelling was designed to demonstrate the shaking effects at the Christchurch Botanic Gardens site (CBGS in the GeoNet network). Figure 16, which is extracted from the GNS Science report, compares the modelled ground surface motions (in terms of ground accelerations) for a potential Alpine Fault earthquake with those for the September and February earthquakes.

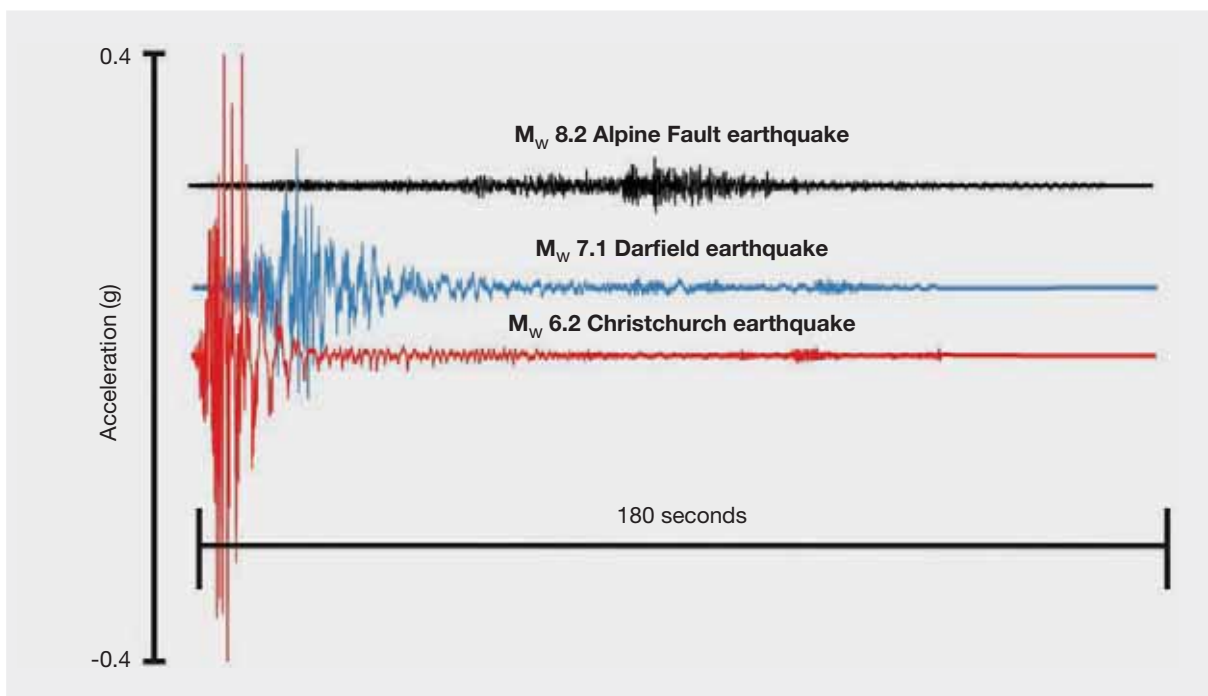

Figure 16: Comparison of modelled ground surface motions for a potential Alpine Fault event and the September 2010 and February 2011 earthquakes (source: GNS Science report 2011/183, July 2011)

**Notes:** Three minutes of synthetic acceleration time histories for the larger of the two horizontal components, in terms of PGA, for a potential Alpine Fault event (black), compared with the accelerations for the magnitude 7.1 4 September earthquake (blue) and the 22 February magnitude 6.2 Christchurch earthquake (red), as recorded in the Christchurch Botanic Gardens GeoNet station (CBGS).

### 2.7.1.8 Aftershocks

Figure 17 illustrates the pattern of aftershocks that followed the September 2010 earthquake.

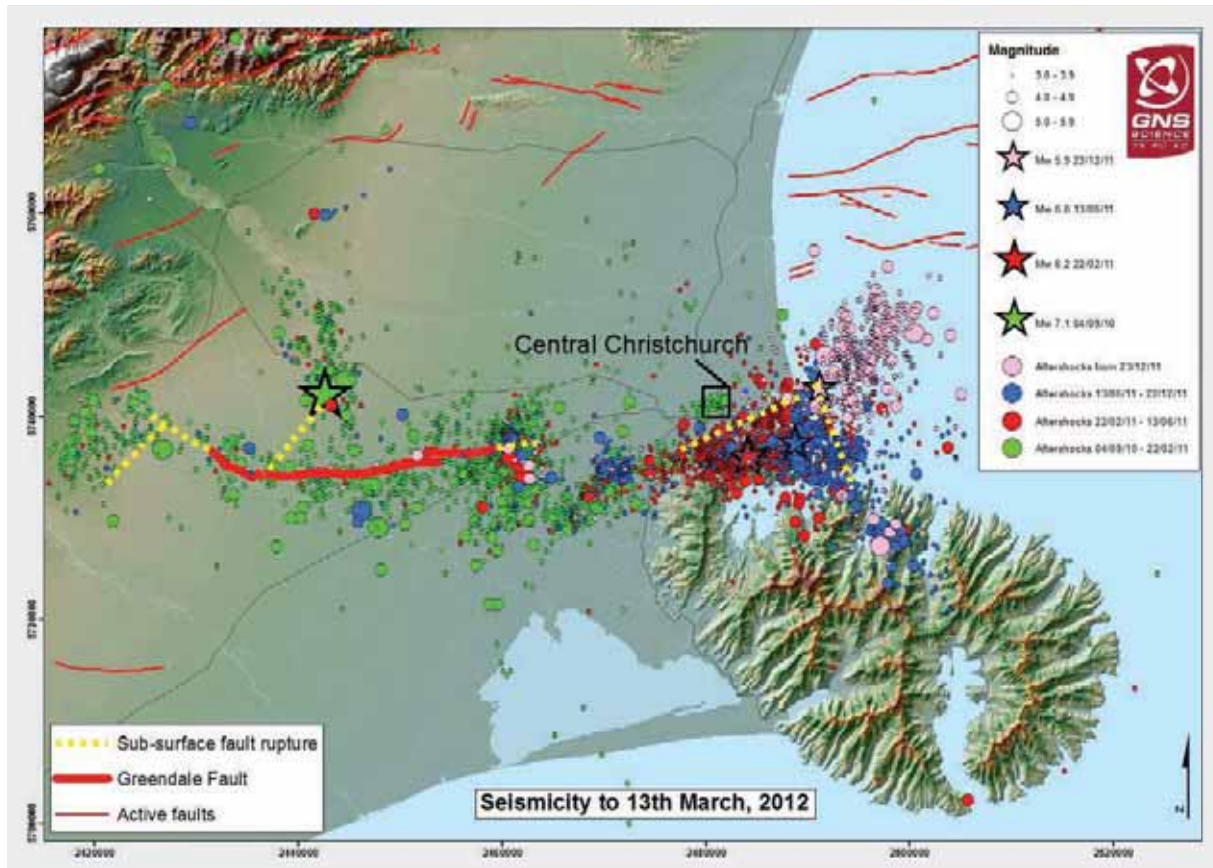

Figure 17: Pattern of aftershocks following September 2010 earthquake (source: GNS Science letter to the Royal Commission, 2 April 2012)<sup>18</sup>

**Notes:** Seismicity up to 13 March 2012, showing the Greendale Fault, the epicentres of the September, February, June and December earthquakes and the associated aftershock activity. The coloured stars indicate the main aftershocks. Circles represent the aftershocks triggered by each event.

We understand that, strictly speaking, an aftershock is an event that subsequently occurs on the same fault as the original earthquake. While aftershocks of that kind have occurred in the Canterbury earthquake sequence, the pattern observed has involved significant earthquakes on faults other than the Greendale Fault. The Boxing Day, February, June and December events were all in that category. We infer from the evidence given by Dr. Webb at the hearing that they can loosely be regarded as aftershocks. However, they can be seen as probably having been triggered by the September earthquake.

Aftershock behaviour normally follows predictable patterns, enabling a rough estimate to be made of what can be expected during the aftershock sequence.

It is possible to make estimates of the number of aftershocks that will occur, based on the historic aftershock sequences. As the ongoing aftershocks are now recorded (in the GeoNet database), if there is a large aftershock, a brief increase in the rate of aftershocks can be anticipated and GNS Science updates its estimates accordingly. It is difficult to predict when the sequence will end, but it appears to be a function of the magnitude of the main shock. The aftershock sequence is not regarded as complete until the rate of occurrence of the aftershocks falls to the rate at which earthquakes were occurring before the main shock. The science also assumes that aftershocks will occur near to the main shock and often within a distance of slightly more than the fault length of the initial rupture. However, that was not true for the

February earthquake: the surface expression of the Greendale Fault is 29.5km in length, with an additional 10km or so beneath the surface. However, the epicentre distance between the September and February earthquakes is about 42km.

For the purposes of the Royal Commission's work, among the significant features of the sequence of events are the facts that the September earthquake of magnitude 7.1 was followed by three aftershocks with magnitudes greater than magnitude 6; that a significant period (five and a half months) elapsed between the September and February events; and that the epicentres of the September and February events were separated by an apparently significant distance. We asked GNS Science to advise us whether these features of the earthquake sequence were unusual.

GNS Science conducted a search of the information recorded in the Centennial Catalogue, a global catalogue of earthquakes occurring in the period from 1900 to 2008.<sup>19</sup> The catalogue has some shortcomings in the early years because of the lack of instrument recording. GNS Science selected earthquakes shallower than 35km and with a magnitude of 6 or more. This meant that information from about 4345 earthquakes was able to be considered.

GNS Science first examined the occasions when there had been large aftershocks following the initial event, looking in particular for aftershocks within a magnitude of 1.1 of the initial shock. The database included 211 main shocks of magnitude 7.1 or more. GNS Science noted that the large number of earthquakes not followed by aftershocks within a magnitude of 1.1 was exaggerated due to the shortcomings in the database. Nevertheless, the analyses suggest that the comparatively high magnitude of three of the aftershocks in the Canterbury sequence is not the usual pattern, with only 1.4 per cent of all the earthquakes analysed having more than three such major aftershocks.

GNS Science also analysed the information about the time difference between the main shock and the largest aftershock, at intervals of one month. Most large aftershocks occurred within the first month, with a very long tail of events over the first year. The period of five and a half months between the September and February events was not exceptional, but only 17 per cent of the earthquakes analysed had major aftershocks more than six months after the initial event.

GNS Science also investigated the distance between the epicentre of each main shock and the largest aftershock. The analysis showed that the 42km distance between the epicentres of the September and February earthquakes was not exceptional: 38 per cent of the earthquake sequences considered had distances greater than 50km.

What these analyses do not consider is the effects of the proximity of the February earthquake to the Christchurch CBD, its very shallow depth and the orientation of the energy produced by the rupture towards the city. It is clear that these aspects of the February event were not anticipated and could not have been, given that the rupture occurred on a previously unknown fault.

### **2.7.1.9 Some conclusions about the characteristics of the earthquakes**

The earthquakes were all shallow, with the majority of the seismic energy released within seven to eight kilometres of the ground surface. Shallow earthquakes cause more intense shaking near the fault than do deep earthquakes. With a shallow earthquake, less dispersion of the released energy can occur. Consequently, shallow earthquakes give intense localised shaking while deep earthquakes give a lower intensity of shaking but over a greater area. The shallowness partly explains the very intense shaking that occurred within a few kilometres of the fault zone. An exception to this was the September earthquake where, as noted previously, directivity effects focused the earthquake's energy towards Christchurch.

The earthquakes were the result of strike-slip and thrust-faulting movements, with the September earthquake occurring on a mixture of blind faults and a fault that was expressed on the surface after the event. The other significant earthquakes, in February, June and December 2011, occurred on blind faults.



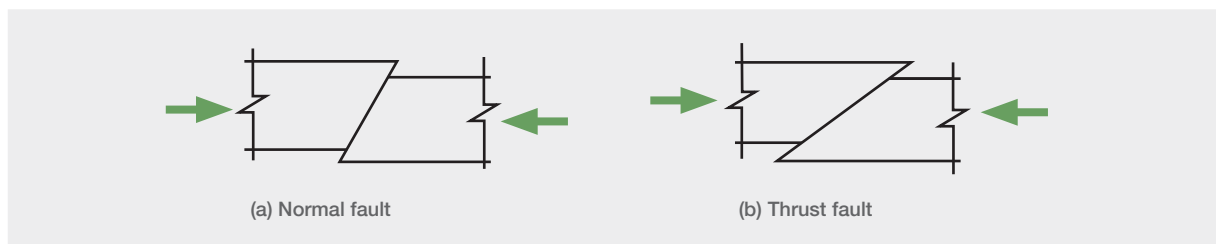

Figure 18: Normal and thrust faults

The faults in the general locality of Christchurch were initially formed more than 25 million years ago when tectonic movements were stretching the area. This caused normal faults to develop, which are steeply inclined to the horizontal, as illustrated in Figure 18(a). If these faults had been generated due to compression in the rock, they would have been less steeply inclined, as shown in Figure 18(b).

In more recent times (in geological terms) the tectonic situation changed, with the area being subjected to compression in the east south-east to west-northwest direction. This change resulted in steeply inclined faults being subjected to compression. The high pressure transmitted across these faults acted to clamp the surfaces together, increasing the friction force sustained before failure, and increasing the strain energy in the rock. The effect is much greater with the steeply inclined fault shown in Figure 18(a) than with the thrust fault shown in Figure 18(b). The steepness of the faults, the compression force that acts across the faults, and the relatively high strength of the greywacke rock underlying the area act to increase the strain energy that can be resisted near the fault.

The faults that generated the Christchurch earthquakes are in a zone of moderate to low seismicity in an area with a low strain rate, as shown in Figure 2. The faults have infrequent movement (with recurrence intervals of each of the faults in excess of 8000 years) and consequently the rock adjacent to the faults is relatively undamaged. Faults that move frequently (i.e., every few hundred years) have relatively low friction zones at the fault interface, and this reduces the shear stress that can be sustained at fracture. Consequently, these major faults often have (for the same fault area) lower levels of strain energy to release when failure occurs. This means that there is a lower intensity of shaking close to the fault.

In summary, faults that:

- are steeply inclined and subject to compression across the plane of the fault;
- generate shallow earthquakes; and
- have long return periods (fail infrequently) due to the low tectonic strain rate;

can be expected to generate high-intensity shaking in an area close to the fault.

A number of other factors that may have influenced the intensity of ground shaking observed in the February earthquake include:

- directivity;
- basin effects; and
- the interaction of deep alluvial soils with softer layers in the top 30m of the ground surface.

The influence of these factors is still being investigated in current research projects.



## 2.8 The New Zealand National Seismic Hazard Model

GNS Science has built and maintains a National Seismic Hazard Model (NSHM) that uses likely magnitudes and frequencies of occurrence of future significant earthquakes to estimate ground shaking levels for use in engineering design. The NSHM estimates future earthquake activity and associated ground shaking for New Zealand.

The NSHM has been developed since the early 1980s and the model as it stood in 2002 was the basis for the design spectra contained in NZS 1170.5: 2004, the current Standard covering earthquake design actions in New Zealand.<sup>20</sup> Section 3 of this Volume explains the design spectra used to assess how different building structures will respond to earthquake actions. The NSHM was significantly updated in 2010 and continues to be developed.<sup>21</sup>

The two main components of the NSHM are the earthquake source model and the predicted ground motions that the source earthquakes are likely to produce.

The 2002 earthquake source model has two main elements. The first, the “fault source” model, is based on over 300 fault sources that have been recognised from detailed geological and geophysical studies. The second, the “background source” model, reflects the fact that it is not practical to identify all active faults in a region because smaller faults of magnitude 7 and lower often lack any surface expression. For this reason, a model of background seismicity comprising earthquakes located at points (as opposed to faults) is used, based on the location of earthquakes occurring between 1840 and 1997 that have not been associated with the known faults.

The GNS Science report explains:

The above two source models are combined by using a regional maximum magnitude,  $M_{\text{cutoff}}$ , below which the background seismicity model is used, with some contribution from the fault model, and above which only the fault source model is used. The implication of this is that an earthquake above  $M_{\text{cutoff}}$  is considered implausible if not identified by an active fault. In the 2010 update to the NSHM (Stirling *et al.*, 2011), the  $M_{\text{cutoff}}$  was revised to  $M=7.2$  for all regions except the Taupo Volcanic Zone, which was assigned  $M_{\text{cutoff}}=6.5$ . The 2002 version of the model used  $M_{\text{cutoff}}=7.0$  for Canterbury. The choice of  $M_{\text{cutoff}}$  is subjective, but ultimately comes down to understanding how complete the knowledge is of the number of active faults capable of producing earthquakes above a given magnitude. In low seismicity areas, or areas with few active faults, the choice of  $M_{\text{cutoff}}$  can have significant implications for the estimated hazard.<sup>22</sup>

The second key component of the NSHM is a ground motion attenuation model that predicts the strength of ground shaking from future earthquakes depending on their magnitude and distance, taking into account the effect of near-surface site conditions and different types of earthquakes.

The attenuation relationship used in the NSHM is based on international models and is modified to reflect local records of earthquake ground shaking. The model also takes into account directivity effects that may occur near to major fault ruptures. In its application in NZS 1170.5, it is assumed that the estimated shaking may be enhanced in the direction perpendicular to the fault for structures with fundamental periods beyond 1.5 seconds for locations within 20km of any of the 11 major faults named in the Standard.

### 2.8.1 Updates to the National Seismic Hazard Model since 2002

Two major updates of the NSHM model were made after publication of the 2002 NSHM. The first was completed in 2008 and focused on the Canterbury region. It included newly identified fault sources that were mainly offshore from North Canterbury, Kaikoura and north-eastern Marlborough. In addition, all fault sources in the Canterbury region were assigned “characteristic” earthquake magnitudes derived from the length and estimated width of each fault source. These were estimates based on the new New Zealand and international scaling relationships. The background seismicity model for all New Zealand was updated to reflect the new Canterbury earthquake data gathered in the period from 1998 to mid-2006.

The second major update was completed in 2010 and included over 200 new fault sources (mainly offshore), bringing the total number to about 530. The New Zealand and international scaling equations used in the Canterbury model were applied to all faults. The Greendale Fault, the source of the September earthquake, was included in the fault source model at a late stage on the basis of a very long estimated recurrence interval. The long recurrence interval means that it has very little effect on the estimated seismic hazard for Christchurch. The background seismicity model was also updated with earthquake data from 2006 to mid-2009 and the associated modelling method was changed after an evaluation of the various methods available.<sup>23</sup>

The GNS Science report advises that probabilistic seismic hazard maps produced from the 2010 revision of the NSHM show a similar pattern of hazard to the 2002 model on a national scale, with some significant

reductions and increases in hazard in certain regions. The most significant differences seen on hazard maps and in uniform hazard spectra are:

- reductions in Auckland and Northland, which are due to the new distributed seismicity model (e.g., Auckland's PGAs show a reduction from just over 0.1g to 0.08g for the approximately 500-year return period);
- increases in the south-east of the North Island due to the new Hikurangi subduction zone modelling (uniform hazard spectra increase at periods of 0.4 seconds and greater in Wellington);
- slight increases in Christchurch for periods lower than about 0.6 seconds due to the new distributed seismicity model; and
- slight increases for Dunedin due to the new distributed seismicity model.

### 2.8.2 Implications of the Canterbury earthquakes for seismic hazard levels in Canterbury

Apart from inclusion of the Greendale Fault, as discussed previously, no attempt was made to include post-September 2010 seismicity in the 2010 NSHM update. It was recognised that hazard estimates would need to be addressed separately for Canterbury. By July 2011, when GNS Science reported to the Royal Commission, it was able to advise that a new seismic model had been developed that reflected its assessment, based on the Canterbury earthquake sequence, that there would be elevated levels of seismic activity in the region, probably for a number of decades. The GNS Science report explained:

This is because shallow crustal earthquakes are always followed by numerous aftershocks, although these do decrease in frequency with time. In addition, there is a possibility that an earthquake of a size comparable to the main shock might be triggered, even if the probability of this remains low. This elevated level of hazard must be considered when reassessing the safety of existing structures and when designing new buildings and infrastructure.<sup>24</sup>

The new seismic hazard model for Canterbury developed by GNS Science led to the adoption of new seismic design coefficients for Canterbury, as discussed below. Before embarking on that discussion, it will be appropriate to explain the process by which the knowledge about seismicity reflected in the NSHM is translated into the rules that govern the design of buildings.

### 2.8.3 Use of the National Seismic Hazard Model in earthquake design

The NSHM is used as the basis for the specification of design motions in NZS 1170.5 and in specific hazard analyses performed for major projects.

As explained in section 3 of this Volume, buildings are designed in accordance with response spectra that are used to gauge how buildings will respond to earthquake motions on different ground conditions. Under NZS 1170.5, the elastic site hazard spectrum used as a basis for structural design is defined by  $C(T)$  where  $T$  is the period of vibration, by:

$$C(T) = C_h(T) Z R N(T,D)$$

where

$C_h(T)$  = the spectral shape factor, which depends on the type of soils;

$Z$  = the hazard factor, a figure that varies with the seismicity of the locality;

$R$  = the return period factor, which reflects the strength of earthquake motions with differing return periods;

$N(T,D)$  = the near-fault factor determined from Clause 3.1.6, which applies within 20km of 11 major faults; and

$D$  = distance from a major fault in km.

In other clauses of the Standard to which the equation refers, the numerical values given are derived from the information in the NSHM. The spectral shape factor differs according to the class of subsoil at the site of interest (Classes A to E are provided for, ranging from strong rock to very soft soil sites). The soil-type classification reflects broad categories of soils that have differing characteristics and depths.

Hazard factors ( $Z$ ), taken from a contour plot of seismicity and values for particular cities and towns, are stated in a table set out in the Standard. The values range from 0.13 (the lowest hazard) to 0.6 (the highest). This is a mapped quantity, derived directly from the NSHM, corresponding to half the 0.5 second value of the "magnitude-weighted" shallow soil spectrum for a return period of 500 years.<sup>25</sup> The  $Z$  value of 0.13, applicable in low-seismicity regions such as Northland, Auckland and Dunedin, is a minimum allowable value under the method used and corresponds to stronger earthquake motions than those with a return period of 500 years in those locations. The minimum  $Z$  value corresponds to two thirds of the 84th percentile motions from a magnitude 6.5 earthquake at a distance of 20km.

The return period is derived from a table that sets out a numerical value for the required annual probability of exceedence for the “limit state” under consideration, as explained further in section 3 of this Volume. There is a range of return periods provided for: in the case of commercial buildings of normal importance, the design earthquake for the Ultimate Limit State is assumed to have a return period of 500 years. Other buildings judged to be of a high level of importance are designed for earthquakes that have return periods of either 1000 or 2500 years.

The near fault factor is based on the distance of the site under consideration from 11 major faults listed in the Standard.

It should also be noted that while NZS 1170.5 deals comprehensively with horizontal earthquake motions, a simpler approach is taken with vertical motions. These are generally taken to be 0.7 times the horizontal spectrum at the same location. The commentary to NZS 1170.5 notes, however, that at locations where the seismic hazard is dominated by a fault closer than 10km, it will be more appropriate to assume that the vertical spectrum is the same as the horizontal spectrum for periods of 0.3 seconds and lower. GNS Science states that the observations in the commentary have been borne out by the nature of some of the vertical spectra in Christchurch, although before the February 2011 earthquake there was no suggestion that the seismic hazard for Christchurch was dominated by nearby faults. In the Royal Commission’s opinion, the provisions of the Standard relating to vertical accelerations need to be reassessed in view of the spectral shapes and magnitudes derived from the recorded ground motions in the Canterbury earthquakes.

#### 2.8.4 Modifications to seismic hazard modelling for Christchurch

GNS Science has advised that the level of seismic hazard in Christchurch is currently higher than the long-term average and that this will continue to be the case for several decades, because of the likely continuation of aftershocks. Although the aftershocks will decrease in frequency with the passage of time, there is also a possibility that an earthquake of an intensity comparable to the main September earthquake will be triggered.

GNS Science has developed a new seismic hazard model for Canterbury to reflect this increased level of hazard. The model takes into account an assessment of likely rates of aftershocks, the small possibility that

larger earthquakes may be triggered and, as with previous models, the normal background seismicity and expectation that large earthquakes will rupture on known faults in the Canterbury region. The model relates to the 50-year period from March 2011.<sup>26</sup> This model was developed using the short-term earthquake probability (STEP) model, which attempts to forecast the short-term behaviour of aftershocks by estimating future rates of earthquakes of various sizes and their spatial distribution.<sup>27</sup> GNS Science has also used the “Every Earthquake a Precursor According to Scale” (EEPAS) model, in which every new earthquake slightly increases the probabilities of future higher-magnitude earthquakes, as well as other models to develop the new approach.<sup>28</sup> The Z factor, which was prescribed in NZS 1170.5 at 0.22, was subsequently raised to 0.3 with a corresponding increase in the return factor R for the serviceability limit state from 0.25 to 0.33.

In November 2011, GNS Science convened an expert panel to further update the seismic hazard model for Canterbury. This update considered recent scientific understanding of the earthquake sequence and responded to the GNS Science evidence to the Royal Commission. The 12-person panel was made up of international and New Zealand-based scientists across a range of fields related to seismic hazard assessment. After presentations on various aspects of the hazard modelling for the Christchurch region, each panel member responded to 50 questions relating to the modelling. The process led to recommendations for weighted combinations of multiple seismicity models for each of the short-term, mid-term and long-term components of the model. Similar weightings were elicited for other aspects of the hazard modelling (e.g. source depth, minimum magnitude, stress-drop modification and epistemic variability in the ground-motion prediction equations (GMPEs)).

A second five-person expert panel workshop convened in March 2012 to decide on the weightings that should be accorded to two New Zealand-specific GMPEs – that of McVerry, which had been used previously, and that of Bradley<sup>29</sup>. Bradley and Cubrinovski showed that the Bradley model, developed before the Canterbury earthquakes, provided a good match for the short-period motions (peak ground acceleration and 0.2s spectral acceleration) recorded in the September and February earthquakes at all distances, and for 1.0s spectral accelerations, except for under-predicting a few sites at source-to-site distances of less than 10km.<sup>30</sup>

This process addressed several issues raised by the reviewers of GNS Science's evidence to the Royal Commission by:

- allowing for the variation between different GMPEs (epistemic uncertainty) by increasing the variance of the McVerry model and adding the Bradley model as a second GMPE that has been evaluated against New Zealand data;
- allowing for different values (5.0, 5.25 and 5.5) of the minimum magnitude to be included in the hazard analysis;
- allowing for different values of the maximum magnitudes (7.2, 7.5 and 8.0) to be included for the distributed-seismicity component of the seismicity modelling;
- adopting a distribution of focal depths from 1–30km and considering finite-source effects by placing the upper limit of the rupturing fault plane at a magnitude-dependent distance above the focus; and
- considering estimates with and without stress-drop modifications.

Directivity effects have not yet been incorporated and GNS Science advises that they will not be until the importance of directivity has been demonstrated through further research.

Revised seismicity rates from the “Expert Elicitation” model have recently been released and incorporate seismicity up to early January 2012. The short-term values are about two-thirds those estimated in June 2011, while the long-term values are about one third of the earlier estimates (see Figure 19). These were incorporated, along with the other changes to hazard modelling (including the addition of the Bradley GMPE), in late March 2012. The percentage changes in the ground motions are lower than those in the seismicity rates.

We understand that GNS Science has provided the Department of Building and Housing (DBH) with estimates of deep soil peak ground accelerations for use in liquefaction assessment that are slightly lower than those used previously: 0.13g instead of 0.15g for an average annual exceedance rate of 1/25. Updates of the peak ground accelerations estimated for shallow soil sites in the Port Hills, and of acceleration response spectra for the CBD and elsewhere, are expected to be available shortly.

The reduced earthquake activity estimates from the expert elicitation process may lead to a different hazard factor,  $Z$ , compared to the 0.3 value that currently applies. This issue is the subject of ongoing consideration as we write.

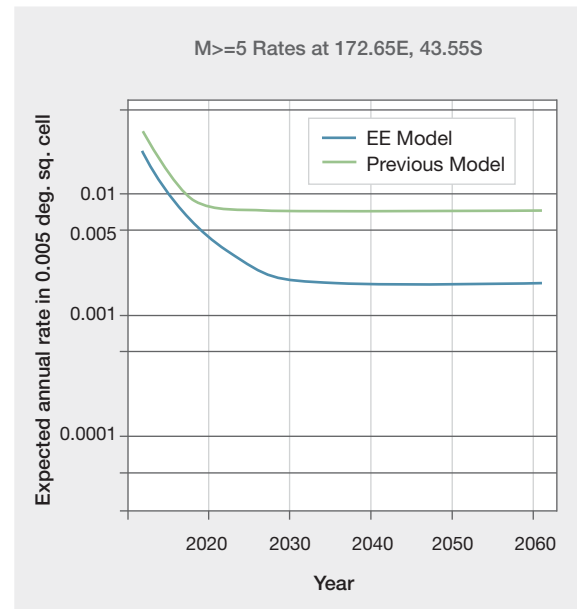

Figure 19: The reduction in estimated seismicity rates from the June 2011 model (upper curve) to the current model (lower curve) (source: Email from GNS Science to the Royal Commission, 24 April 2012)<sup>31</sup>

### 2.8.5 Magnitude weighting

The duration of strong ground shaking influences the extent of the damage that occurs in an earthquake. A major factor influencing the duration is the length of the fault and this is reflected in the magnitude ( $M_w$ ) of the earthquake. To make allowance for the duration of shaking from different potential earthquakes, a magnitude weighting factor can be used to assess the contribution of each potential earthquake considered in developing the design response spectrum. The magnitude weighting factor takes the form of the expression

$(M_w / 7.5)^x$ , where  $x$  can take different values for different types of application.

The design response spectra in NZS 1170.5 were developed using a magnitude weighting factor for the period range of 0 to 0.5 seconds, with a value of  $x = 1.285$ . Above 0.5 seconds the factor was not applied.

We understand that for the proposed design spectra for Christchurch, magnitude weighting factors are to be applied to the full period range. We agree that this is logical. Different values of  $x$  are to be used for structural design (1.285), for liquefaction (2.5) and for rock fall (1). We understand that the 2.5 value comes from recent research and that for rockfall the critical value is the peak acceleration and hence a value of 1 is logical. However, the value of 1.285 appears to come from a previous liquefaction study<sup>32</sup> and following limited consideration it was assumed it could be applied to ductile structures.<sup>33</sup> We recommend that research be undertaken to provide a more logical basis for the weighting magnification factor for structures. In the meantime the value of  $x$  should be taken as 1.285.

Allowance should be made for the magnitude weighting factor for the purpose of comparing an earthquake with a design spectrum. The February earthquake had a magnitude,  $M_{wv}$ , of 6.2 and the corresponding magnitude weighting factor is  $(6.2/7.5)^{1.285} = 0.78$ . To compare this spectrum calculated from the recorded ground motion with a design spectrum it should be multiplied by 0.78. Figure 20 illustrates the effect that this modification has on a comparison with the design spectrum for Christchurch on type D soils with a seismic hazard factor of 0.22. The earthquake response spectrum shown in the figure was calculated from the averaged ground motions at the four sites in the CBD for the east–west motion.

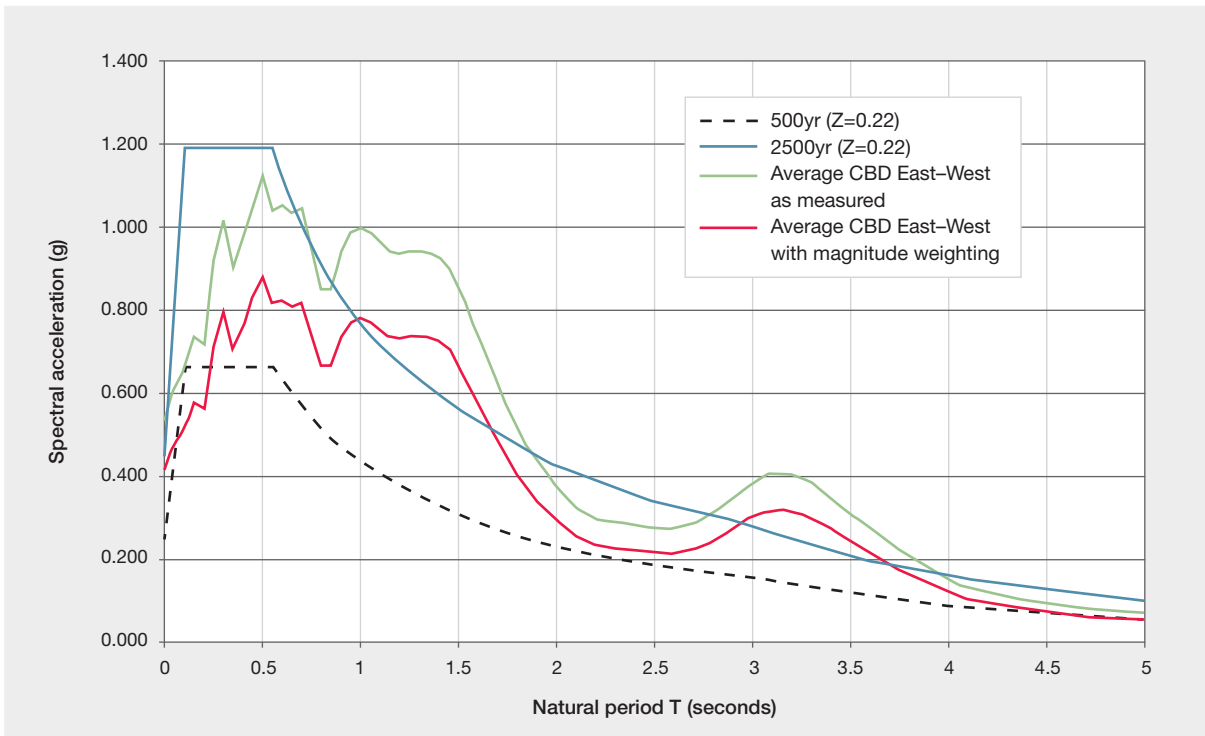

Figure 20: Influence of the magnitude weighting on average east–west spectra values for the 22 February 2011 earthquake



## 2.9 Conclusions

For the reasons addressed at the outset of this section, it was necessary for us to understand the nature and severity of the Canterbury earthquakes and also to understand the nature of the earthquake risk that affects the country as a whole.

Uncertainty is inherent in the prediction of earthquakes, particularly in terms of the locations, magnitude and timing of events. There is growing knowledge about the number of active faults in New Zealand, but it is difficult to locate some of them in advance where there is no history of rupture with surface expression. This is a particular problem in the Canterbury region because of the nature of the subsurface conditions.

Although we are not required by the Terms of Reference to make recommendations on the subject of seismicity, we do recommend that research continues into the location of active faults near Christchurch and other population centres in New Zealand. While it will not be possible to build a picture that is complete, we consider that there is obvious merit in developing the knowledge of active faults whose rupture might impact on our cities and major towns.

The September earthquake was a significant event in New Zealand terms and has triggered an ongoing sequence of aftershocks. The return periods of the September and February earthquakes have been estimated as at least 8000 years. The shaking that was produced by the September earthquake was, with some qualifications, generally comparable with that anticipated for a design earthquake with a return period of 500 years in the current Earthquake Actions Standard (NZS 1170.5) that is used for building design purposes. The shaking produced by the February earthquake was much more intense than envisaged by NZS 1170.5 for the ultimate limit state. The contrast between the September and February earthquakes is such as to question assumptions that might otherwise have continued to be made that an aftershock will be less damaging than the earthquake that triggered it. The February earthquake was the result of a rupture on a different fault, closer to the Christchurch CBD. As a consequence its effects on the city were much more pronounced. Further, the predominant direction of the shaking meant that buildings were tested from a different direction to that which applied in September.

We consider that the country can have confidence in the degree of knowledge and understanding of the seismicity of New Zealand possessed by GNS Science and in the manner in which the knowledge of earthquake risk is reflected in the ongoing development of the building Standards. The response to the Canterbury earthquakes has included the gathering of further knowledge about the number and location of active faults in the Canterbury region and those efforts should continue. In addition, GNS Science has responded in a measured way to suggestions made in the reviews of the GNS Science report and in the evidence of Adjunct Professor Abrahamson. Refinements to the NSHM are being made. These will result in appropriate adjustments being made to the relevant building design standards. This is not a subject we can advance by this Report. It is a matter for ongoing research and consideration. However, in our view, confidence is justified in the processes being followed.

Over the last 160 years Christchurch has been subjected to a number of earthquakes. The majority of these were generated on faults to the north of Canterbury or in the mountains to the west. There have been a few earthquakes from local faults but none anywhere near as intense as the earthquake sequence that started in September 2010.

Finally, we repeat our view that the provisions of NZS 1170.5 relating to vertical accelerations need review and that research should be undertaken to give a firmer analytical basis to magnitude weighting used in developing the response spectra for structural design.

## Recommendations

We recommend that:

1. Research continues into the location of active faults near Christchurch and other population centres in New Zealand, to build as complete a picture as possible for cities and major towns.
2. The provisions of the Earthquake Actions Standard, NZS 1170.5, relating to vertical accelerations be reviewed. (See also recommendations 33 and 34 in Volume 2 of this Report.)



## Annex 1: Tectonic structure of the Canterbury region

Much of the Canterbury region is located within the wide zone of active earth deformation associated with the oblique collision between the Australian and Pacific tectonic plates east of the Alpine Fault (see Figure 21).

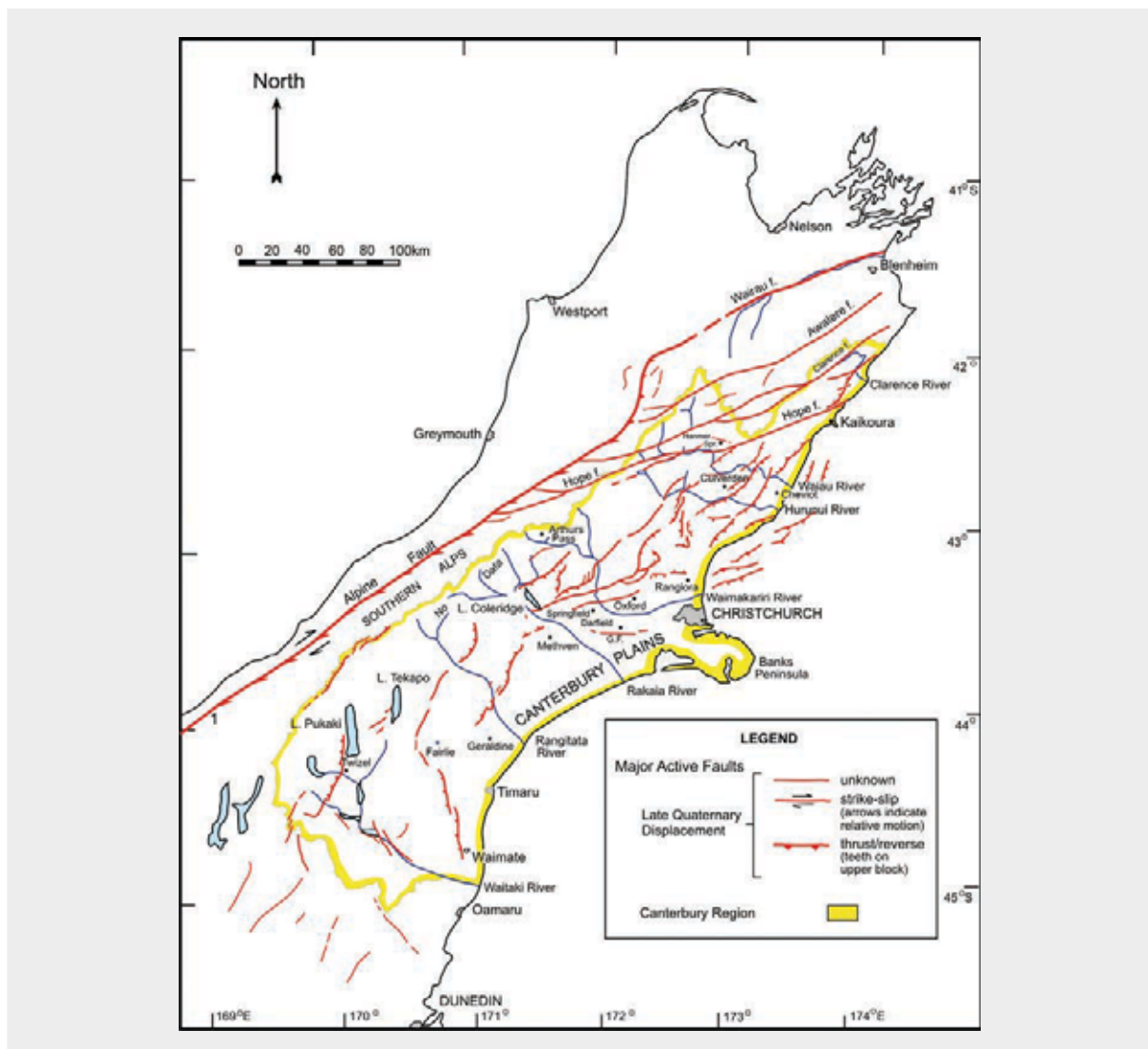

Figure 21: Map of the known active faults in the Canterbury region (source: GNS Science report 2011/183, July 2011, modified from Pettinga et. al. (1998))

The present-day tectonic tempo of active earth deformation is greatest along the narrow zone adjacent to the Alpine Fault, and where the plate boundary zone transfers across the South Island, through the Marlborough and North Canterbury regions to link with the offshore trench and subduction zone from near Kaikoura northward. In the North Canterbury region, the southward transition from subduction to continental collision is associated with tectonic shortening, crustal

thickening and uplift. Landforms reflect the ongoing nature of this active earth deformation, and also show that the Australia-Pacific Plate boundary zone deformation has progressively widened here, and continues to do so, during the Quaternary (~ last 1-2 million years). East of the main divide of the Southern Alps, in central and south Canterbury, the tempo of tectonic deformation progressively diminishes to the east and south-east.

The upper crustal geological structure of the north Canterbury region is dominated by north-east trending active faults and folds that accommodate the transfer of relative plate motion between the Hikurangi Trough and the Alpine Fault and the Southern Alps to the south-west. For the central and south Canterbury region, structures are generally more northerly in trend and are forming in response to the continent to continent collision zone of the eastern side of the deformation wedge to the Southern Alps.

The regions in and around Canterbury can be divided into eight distinct structural domains in which individual active faults are fundamentally related in terms of their tectonic setting, style, geometry and rates of deformation with respect to the plate boundary zone. These domains are set out in Figure 22.

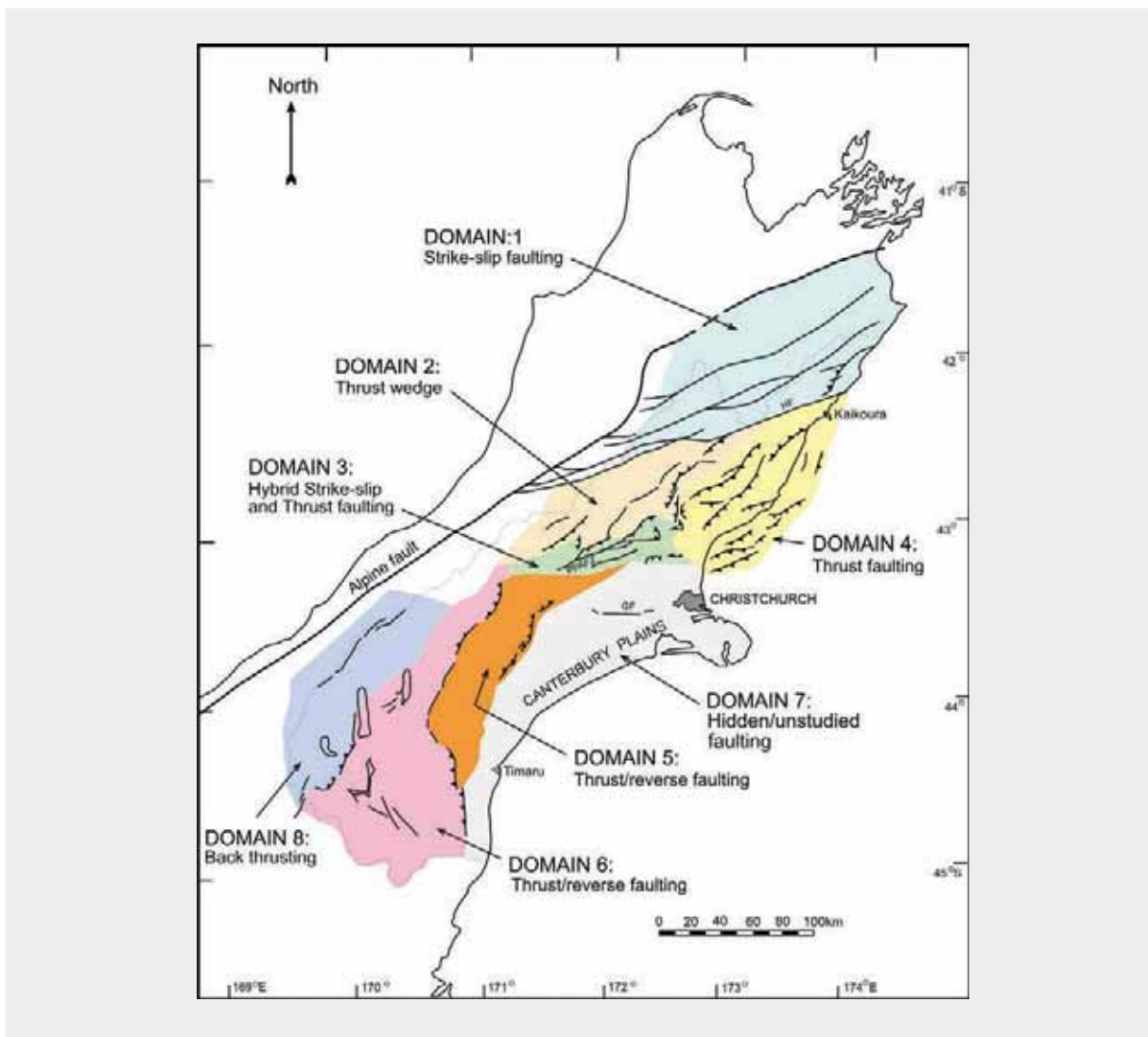

Figure 22: Summary map of structural domains 1–8 for the Canterbury region (source: GNS Science report 2011/183, July 2011, modified from Pettinga et al. (1998))

The eight domains are:

- Domain 1 – Marlborough Fault Zone: A major system of north-eastern-trending strike-slip faults including the Hope, Clarence, Awatere and Wairau Faults, which near their south-western and north-eastern terminations splay and form into oblique thrust faults. Along the Kaikoura coast, both north and south of the Hope Fault, thrust faults, dipping mainly due west, serve to dissipate motion on this fault and accommodate crustal shortening associated with subduction of oceanic crust of the Pacific Plate.
- Domain 2 – West Culverden Fault Zone: A west-dipping system of thrusts and/or reverse faults and fault-related folds are mapped to the west of Culverden Basin. This range-front system of faults represents the eastern margin of the wedge-shaped Southern Alps foothills forming this structural domain in North Canterbury.
- Domain 3 – Porters Pass-Amberley Fault Zone: The Southern Alps foothills, and range front along the north-western margin of the Canterbury plains, are evolving in response to a hybrid system of interconnected east-northeast-trending strike-slip faults, and linking oblique thrusts and/or reverse faults with associated fault-related folds. The Porters Pass-Amberley Fault Zone is a juvenile fault system reflecting the latest phase of plate boundary zone widening in the late Pleistocene (0.5 to ~1 million years).
- Domain 4 – North Canterbury Fold and Fault Belt: Southwest from Kaikoura, thrust faults extend through the north-eastern part of the onshore Canterbury region, and offshore across the continental shelf and slope. The thrusts are evolving in response to oblique plate convergence and the transition to continent to continent collision west of the Chatham Rise. Thrust faults are typically associated with strongly asymmetric folds involving greywacke basement and Tertiary cover rocks, and are expressed as topographic ridges separated by fault-related synclinal valleys floored by Quaternary alluvium and Tertiary formations. These north-eastern-striking thrusts extend to within five kilometres of the Hope Fault, implying that major right-lateral shear associated with the transfer of plate motion across the northern South Island is mainly restricted to the Hope Fault and other faults of the Marlborough Fault System. Further south, the east-dipping thrusts extend west to the foot of the main ranges, along the north margin of the Canterbury plains and south-western end of Culverden basin.
- Domain 5 – Mt Hutt-Mt Peel Fault Zone: The active earth deformation forming the Southern Alps and eastern foothills is driven by the continent to continent plate collision across the central South Island. The eastern range front is characterised by active thrust faulting forming a complex segmented array of faults, folds and associated ground warping along the western margin of the Canterbury plains from near Mt Hutt to south of Mt Peel.
- Domain 6 – South Canterbury Zone: Further south, the margin of the Southern Alps is again defined by a number of thrust faults east of the Mackenzie Basin and south of the Rangitata River. Major fault zones are mapped along the eastern range front of the Hunter Hills, and the Fox Peak Fault Zone defines the boundary between Domains 5 and 6.
- Domain 7 – Canterbury Plains Zone: Active earth deformation, mostly obscured beneath the Quaternary alluvium of the Canterbury plains is indicated by earthquake activity. The 4 September 2010 right-lateral-slip Greendale Fault surface rupture associated with the M7.1 September earthquake is one such structure. This was further reinforced by the subsurface ruptures associated with the 22 February and 13 June 2011 earthquakes, both on previously unrecognised buried faults in the subsurface beneath Christchurch and surrounds. The Canterbury plains region thus needs to be a target for future research to locate and document other hidden faults capable of generating moderate to large earthquakes in the region.
- Domain 8 – Southern Alps Zone: Major active faults located in the area east of the main divide in central South Island include the Ostler Thrust Fault Zone and the Main Divide Fault Zone. Deformation is accommodated on numerous oblique reverse/thrust faults, and is reflected by the crustal uplift within the Southern Alps.

## References:

---

1. Webb, T.H. (compiler). (July 2011). *The Canterbury Earthquake Sequence and Implications for Seismic Design Levels*. GNS Science Consultancy Report 2011/183. Christchurch, New Zealand: Canterbury Earthquakes Royal Commission.
2. Messrs Webb, McVerry and Berryman of GNS Science, and Professor Pettinga of the University of Canterbury.
3. GNS Science Consultancy Report 2011/183. (July 2011).
4. Cox, S., & Southerland, R. (2007). Regional geological framework of South Island, New Zealand, and its significance for understanding the active plate boundary. In Okaya, D., Stern, T., & Davey, F. (Eds.), *A Continental Plate Boundary: Tectonics at South Island, New Zealand*. American Geophysical Union Geophysical Monograph series 175: 19-46; And Pettinga, J.R., Yetton, M.D., Van Dissen, R.J., Downes, G.L. (2001) Earthquake Source Identification and Characterisation for the Canterbury Region, South Island, New Zealand. *Bulletin of the NZ Society for Earthquake Engineering*, 34(4): 282-317; And Wallace, L.M., Beavan, R.J., McCaffrey, R., Berryman, K.R., Denys, P. (2007) Balancing the Plate Motion Budgets in the South Island, New Zealand using GPS, geological and seismological data. *Geophysical Journal International*, 168 (1): 332-352.
5. Wallace L.M., et al. (2007). Balancing the plate motion budget in the South Island, New Zealand using GPS, geological and seismological data. *Geophysical Journal International*, 168(1): 332-352.
6. GNS Science Consultancy Report 2011/183. (July 2011).
7. Pettinga, J.R., et al. (2001).
8. GNS Science Consultancy Report 2011/183. (July 2011)
9. The description uses the terminology earlier set out to define the nature of the faults.
10. The GNS Science Consultancy Report 2011/183 (July 2011) defines an active fault as one that is likely to move within a period of concern to society, and states that a fault is considered to be active in the Canterbury region if it has moved in the last 125,000 years.
11. GNS Science Consultancy Report 2011/183. (July 2011).
12. GeoNet is a project funded by the Earthquake Commission (EQC) in which geophysical data is collected from field instruments and third party sources, and subsequently processed and maintained in archives. The information about earthquakes is derived from a countrywide network of seismic stations that transmit their data to the GeoNet Management Centre where it is analysed by automated processes. The seismic stations operated by GeoNet consist of a seismometer and a seismograph. The former generates a small electrical current in response to ground shaking, which is digitised by the seismograph and transmitted continuously to the data management centre in real time. This information is used to locate the earthquakes. There is also a network of strong-motion seismographs, which only transmit data whenever they detect a higher level of shaking. The GeoNet website has been frequently referred to by members of the public in Canterbury after 4 September 2010. It has enabled them to check their own estimates of the strength of the latest aftershock against what the instruments are reporting.
13. GNS Science Consultancy Report 2011/183. (July 2011)
14. Bradley, B. (January 2012). *Ground Motion and Seismicity Aspects of the 4 September 2010 Darfield and 22 February 2011 Christchurch Earthquakes: Technical paper prepared for the Canterbury Earthquakes Royal Commission*. Christchurch, New Zealand: Canterbury Earthquakes Royal Commission.
15. Villamor P., Barrell, D., Litchfield, N., Van Dissen, R., Hornblow, S., and Levick, S. (2011). *Greendale Fault investigation of surface rupture characteristics for fault avoidance zonation*. GNS Science Consultancy Report 2011/121. Lower Hutt, New Zealand: GNS Science.

16. These are the CHHC (Christchurch Hospital), CCCC (Christchurch Catholic Cathedral College), CBGS (Christchurch Botanic Gardens) and REHS (Christchurch Resthaven) sites.
17. Sutherland, R., Eberhart-Phillips, D., Harris, R.A., Stern, T.A., Beavan, R.J., Ellis, S.M., Henrys, S.A., Cox, S.C., Norris, R.J., Berryman, K.R., Townend, J., Bannister, S.C., Pettinga, J., Leitner, B., Wallace, L.M., Little, T.A., Cooper, A.F., Yetton, M., Stirling, M.W. (2007). Do great earthquakes occur on the Alpine Fault in central South Island, New Zealand? In Okaya, D., Stern, T., & Davey, F. (Eds.), *A Continental Plate Boundary: Tectonics at South Island, New Zealand*. American Geophysical Union Geophysical Monograph series 175: 235-251.
18. Letter from Terry Webb, Anna Kaiser and Stephen Bannister, GNS Science, to Justine Gilliland, Executive Director, the Royal Commission, 2 April 2012. Letter Report No. CR 2012/94 LR.
19. Engdahl, E.R., & Villaseñor, A. (2002). Global Seismicity: 1900–1999. In Lee, W.H.K., Kanamori, H., Jennings, P.C., & Kisslinger, C. (Eds.), *International Handbook of Earthquake and Engineering Seismology* (pp. 665–690). United States: Academic Press.
20. NZS 1170.5:2004. *Structural Design Actions Part 5 – Earthquake Actions-New Zealand*. Standards New Zealand.
21. Stirling, M.W., McVerry, G.H., Gerstenberger, M., Litchfield, N.J., Van Dissen, R., Berryman, K.R., Langridge, R.M., Nicol, A., Smith, W.D., Villamor, P., Wallace, L., Clark, K., Reyners, M., Barnes, P., Lamarche, G., Nodder, S., Pettinga, J., Bradley, B., Buxton, R., Rhoades, D. and Jacobs, K. (2011). National Seismic Hazard Model for New Zealand:2010 Update. *Bulletin of the Seismological Society of America* (submitted).
22. GNS Science Consultancy Report 2011/183. (July 2011)
23. Stirling, M. W., et al. (2011).
24. GNS Science Consultancy Report 2011/183. (July 2011).
25. The GNS Science report contained an explanation of ‘magnitude weighting’, which we set out in section 2.8.5.
26. The model is explained in Gerstenberger, M.C., Rhoades, D.A., Berryman, K., McVerry, G.H., Stirling, M.W., and Webb, T. (2011). *Update of the Z-factor for Christchurch considering earthquake clustering following the Darfield earthquake*. GNS Science Report 2011/29. Lower Hutt, Wellington: GNS Science.
27. Gerstenberger, M., Weimer, S., Jones, L. M. and Reasenber, P., A. (2005). Real-time forecasts of tomorrow’s earthquakes in California. *Nature*, 435:328-331.
28. Rhoades, D.A., & Evison, F.F. (2004). Long-range earthquake forecasting with every earthquake a precursor according to scale. *Pure and applied geophysics*, 161(1): 47-72.
29. Bradley, B.A. (2010). *New Zealand-specific pseudo-spectral acceleration ground motion prediction equations based on foreign models*. Report No. 2010-13. Department of Civil and Natural Resources Engineering. Christchurch, New Zealand: University of Canterbury; And McVerry, G.H, Zhao, J.X., Abrahamson, N.A., Somerville, P.G. (2006). New Zealand acceleration response spectrum attenuation relations for crustal and subduction zone earthquakes. *Bulletin of the New Zealand National Society for Earthquake Engineering*, 39(1): 1-58.
30. Bradley, B.A. and Cubrinovski, M. (2011). Near-source strong ground motions observed in the 22 February 2011 Christchurch earthquake. *Bulletin of the New Zealand Society for Earthquake Engineering*, 44(4): 181-194.
31. Email from T. Webb, GNS Science to Linda Gibb, Senior Analyst, Royal Commission, 24 April 2012.
32. Seed, H.B. and Idris, I.M. (1982). *Ground motions and soil liquefaction during earthquakes*. Monograph MNO-5. Oakland, California, United States of America: Earthquake Engineering Research Institute. And Idriss, I.M. (1985). *Evaluating seismic risk in engineering practice*. Proceedings of the 11th International Conference of Soil Mechanics and Foundation Engineering, 1:255-320.
33. Kennedy, R.P., Short, S.A., Merz, K.L., Tokarz, F.F., Idriss, I.M., Power, M.S. and Sadigh, K. (1984). *Engineering characterization of ground motion*. Report by Structural Mechanics Associates, Inc. and Woodward-Clyde Consultants to the US Nuclear Regulatory Commission. NUREG/CR-3805.



# Section 3: Introduction to the seismic design of buildings

## 3.1. Structural actions

When a structural member such as a beam, column or wall is subjected to forces that are normal (i.e., at right angles) to the span of the member, bending moments and shear forces are induced.

These actions are internal to the member and are most simply envisaged by considering the forces at an imaginary cut through the member. The portion of the structure separated by the cut is known as a free body, see Figure 1(a) and (b). The forces acting at this section are required to satisfy equilibrium, which stops the free body from rotating or moving.

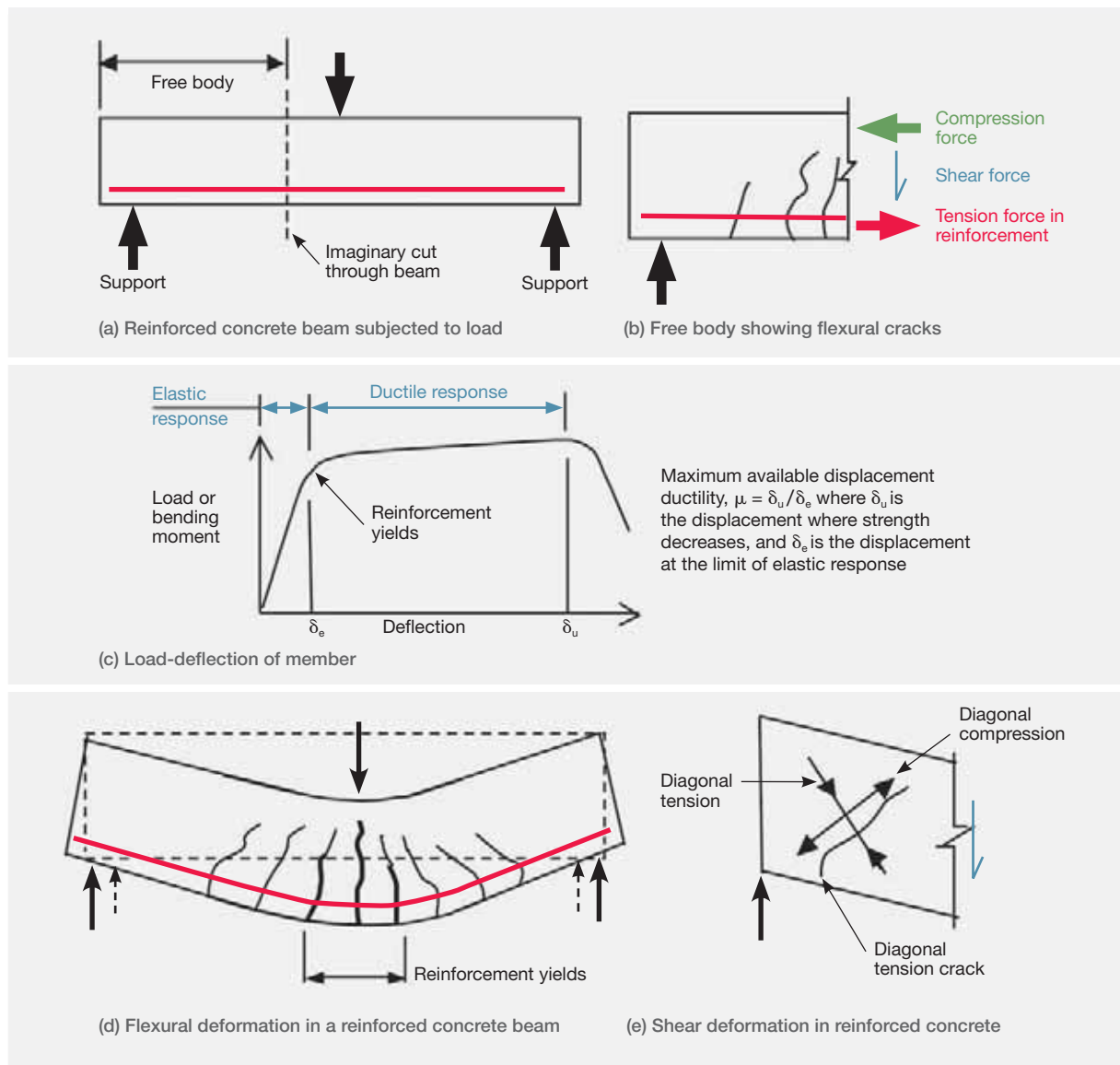

Figure 1: Structural actions in a reinforced concrete beam

Loads applied in a direction normal to the axis of a structural member cause it to bend. The internal action associated with this deformation is known as a bending moment, which induces tension on one side of the member and compression on the other side, as illustrated in Figure 1(b). Owing to the low tensile strength of concrete, cracks form in the regions subjected to tension. When these cracks are initiated the tension force previously resisted by the concrete is transferred to the reinforcement, as shown in Figure 1(b). If the load is increased, a stage is reached when the tension force in the reinforcement causes it to yield. This results in the cracks opening further and the deflection increasing. Once yielding of the reinforcement occurs the member can only take a small additional increase in force, as shown in Figure 1(c). Figure 1(d) shows a beam subject to a load that causes the reinforcement to yield. The ability of the member to deform without losing strength above the point where the reinforcement yields is referred to as ductile behaviour. The zone containing the yielding reinforcement is known as a plastic hinge or plastic region. The tensile strains in the reinforcement are greater than the compression strains in the concrete (on the other side of the member) and consequently the member as a whole increases in length. This is known as elongation, which can become significant when extensive plastic hinging occurs.

Shear forces in a member prevent the free body from sliding at the imagined cut. This force induces diagonal tensile and diagonal compression stresses in the member, which cause the member to deform, as shown in Figure 1(e). Owing to the low tensile strength of concrete the diagonal tensile stresses can cause diagonal cracks to form in the concrete. These are often referred to as shear cracks. These cracks limit the shear strength that can be carried by the concrete. To prevent this type of failure, stirrups are used to tie together portions of the member on each side of the diagonal crack.

The load deflection characteristics of structural steel members are in many respects similar to those of a reinforced concrete element. The yielding of the steel in the flanges in tension and/or compression gives the member a ductile performance similar to that shown in Figure 1(d). Shear forces induce diagonal tension and compression forces in the web. If the diagonal compression stresses are of sufficient magnitude and the web is not adequately restrained by the addition of web stiffeners, buckling of the web can occur.

Composite steel concrete beams are often used in buildings and bridges. Often they take the form of a concrete floor slab cast onto the top flange of a

steel beam. Studs are welded onto the steel beam to anchor the concrete to the top flange so the slab acts compositely with the beam. This has the advantage of increasing the strength and stiffness of the beam while the slab helps restrain it against buckling. Elongation can occur in bending, but very much less than with reinforced concrete.

## 3.2 Seismic design of buildings

### 3.2.1 Introduction

The discussion below gives a brief outline of the concepts involved in seismic design of buildings.

Current New Zealand practice is to design buildings to satisfy two sets of design criteria, namely the serviceability limit state (SLS) and ultimate limit state (ULS).

The earthquake design actions for the two limit states are based on the predicted earthquake magnitudes that on average are expected to occur once in the given return periods. As noted later, the length of the return period used for the design limit states varies, depending on the importance of the building to the community.

The SLS involves designing the building so it remains fit for use in the event of an earthquake with a magnitude of shaking that may be expected to occur once or twice during the design life of the building. If damaged in such an event it should be repairable at low cost. Structures required for essential services after a major earthquake or other major emergencies are designed to sustain a higher level of seismic actions in the SLS.

For the ULS the design criteria have been developed to ensure that life is protected in the event of a major earthquake. This is achieved by requiring the building to have suitable levels of strength, stiffness and ductility to survive a major earthquake without collapsing as a result of structural failure. For commercial buildings of normal importance this major earthquake is assumed to have a return period of 500 years. Post-disaster structures, structures that are designed to contain significant numbers of people, and school buildings used for teaching are designed for earthquake actions with return periods of 2500 and 1000 years respectively (assuming a building design life of 50 years). Satisfying the design criteria for the ULS should enable building to be repaired after earthquakes that are more intense than those envisaged for the SLS. However, the ULS design criteria do not imply that repairs are possible after an ULS earthquake.

Protection against collapse in most modern buildings is provided by ensuring that in the event of a major earthquake the structures will behave in a ductile manner. This involves cracking of concrete and yielding of reinforcement in reinforced concrete buildings and yielding of structural steel members in steel buildings. This causes damage to structural elements as well as damage to non-structural elements such as the linings in the building. A consequence of this is that protection against collapse and protection of life may be at the expense of the building, which may have to be demolished after the earthquake. Ensuring buildings have adequate ductility to satisfy the ULS is achieved through a process called capacity design, which is explained later in this section.

Design seismic actions, consisting of forces and displacements that a building must be able to sustain, are determined from analyses carried out to criteria specified in the Structural Design Actions Standard, AS/NZS 1170.0<sup>1</sup> and Earthquake Actions Standard, NZS 1170.5.<sup>2</sup> Design actions depend on the predicted dynamic characteristics of the structure, the seismicity of the region, and the type of soils on which the building is founded. In Christchurch the soils consist of deep alluvial deposits of sand, silt and shingle. The deep relatively soft alluvial soils increase the magnitude of the long-period vibrations in the ground motion compared with stiff soil or rock sites.

The way in which a building behaves in an earthquake depends to an appreciable extent on its dynamic characteristics. When the natural period of vibration of a structure is similar to that of the ground motion, resonance can occur, vigorously shaking the structure. Thus houses with one or two storeys, which have a high natural frequency (or low period) of vibration, are shaken more vigorously on the Port Hills, where there are shallow stiff soils, compared to the adjacent plains, where there are deep alluvial soils. In the same way multi-storey buildings, which have a relatively long natural period of vibration, when built on the deep alluvial soils in Christchurch are subjected to greater forces and displacements in an earthquake than equivalent tall buildings on the Port Hills.

### 3.2.2 Response spectra

Response spectra form the basis of design for seismic actions. They are used to gauge how buildings with different dynamic and ductile characteristics will respond to earthquake motion under given ground conditions. Design response spectra have been developed from a large number of recorded ground motions. As every earthquake ground motion is unique, the design response spectra are based on averaged recorded motions from a large number of earthquakes.

A response spectrum of an earthquake is obtained by applying the measured ground motion to a simple structure that has a single mode of deformation, known as a Single Degree of Freedom (SDOF) structure. The response of such a structure depends on its natural period of oscillation, which is a function of its mass and stiffness. To derive a response spectrum for a single earthquake, SDOF structures are analysed under the measured ground motion, and the maximum response in terms of the peak acceleration and/or the peak displacement of the mass relative to the ground is recorded. The analysis is repeated for SDOF structures with different periods of vibration and the recorded values are graphed (Figure 2). The result is a response spectrum for accelerations or displacements, which can be used as a basis for assessing forces and/or displacements in buildings.

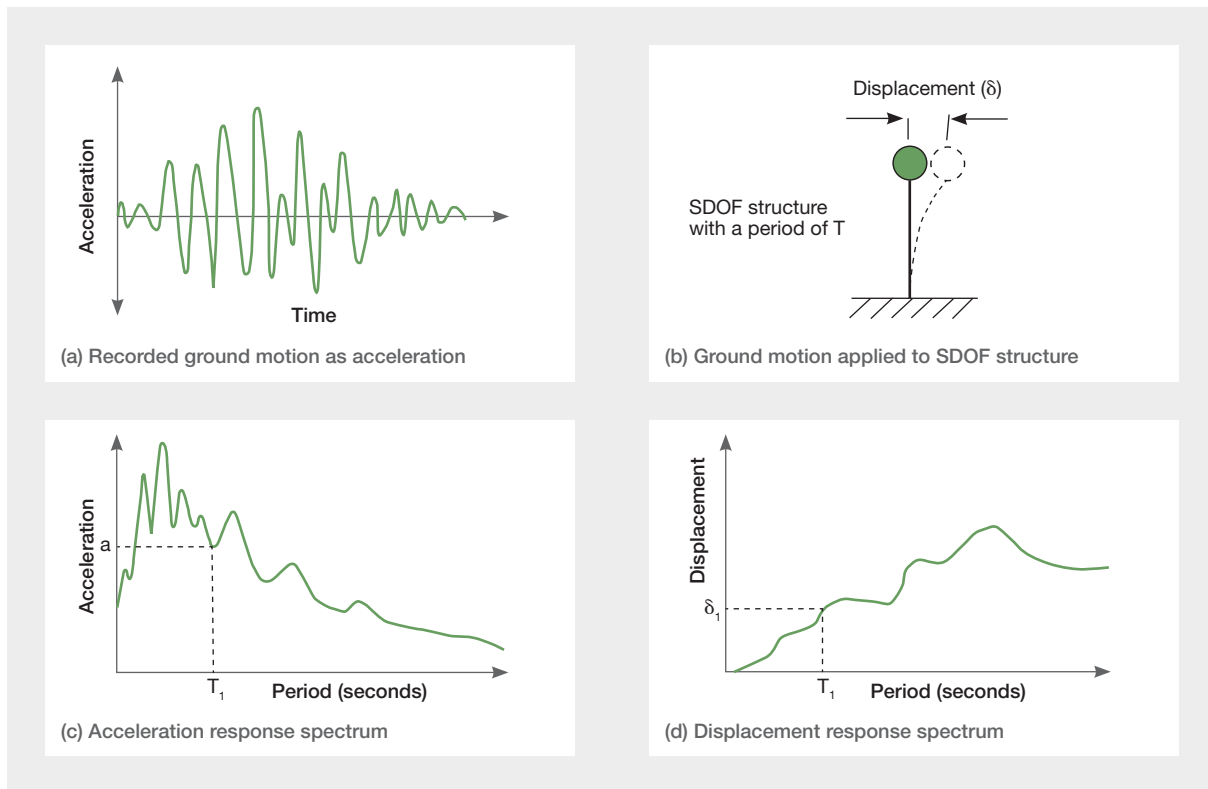

Figure 2: Response spectra for an earthquake

Structural design codes generally contain design response spectra for elastically-responding SDOF structures, assuming that the energy dissipation that occurs is represented by five per cent equivalent viscous damping, as shown in Figure 3(b). These curves are derived by considering the response spectra calculated for a large number of earthquakes, which in NZS 1170.5 are scaled to represent actions associated with the magnitude of an earthquake that on average is expected to occur once in a period of 500 years. As there is a large amount of scatter in the shape of response spectra the design curves are smoothed shapes, which represent the general trends and magnitudes observed in actual earthquakes.

The five per cent equivalent viscous damping represents energy dissipation that occurs in structures because of friction in the building, interaction between the supporting soil and foundations, and other effects that are not easily quantified. Damping limits the extent of structural response.

Acceleration spectra are particularly useful for design as the lateral force induced by a mass in a structure is equal to the mass multiplied by its acceleration. To simplify calculations of the maximum forces, acceleration response spectra are given in terms of the recorded acceleration divided by  $g$ , the acceleration

due to gravity ( $9.81\text{m/s}^2$ ). With this simplification, the maximum inertial force induced on a mass is equal to its weight multiplied by the appropriate acceleration response spectrum coefficient for the period of the SDOF structure.

A basic assumption with the use of response spectra is that the structure has the same stiffness and strength for both the forwards and backwards displacement. If this condition is not satisfied, allowance needs to be made for the tendency of the structure to displace further in the weaker or more flexible direction than in the other direction.

Ground conditions have a major influence on the shape of response spectra. In design codes of practice this is covered by defining a number of response spectra to cover the range of different soil conditions. As noted previously, soft soils increase the response in the longer period range, while with stiff soils, such as rock, the response is higher in the short period range and lower in the long period range. This is shown in Figure 3(a), which shows response spectra for two sites in Lyttelton, which are close together but on very different soils.



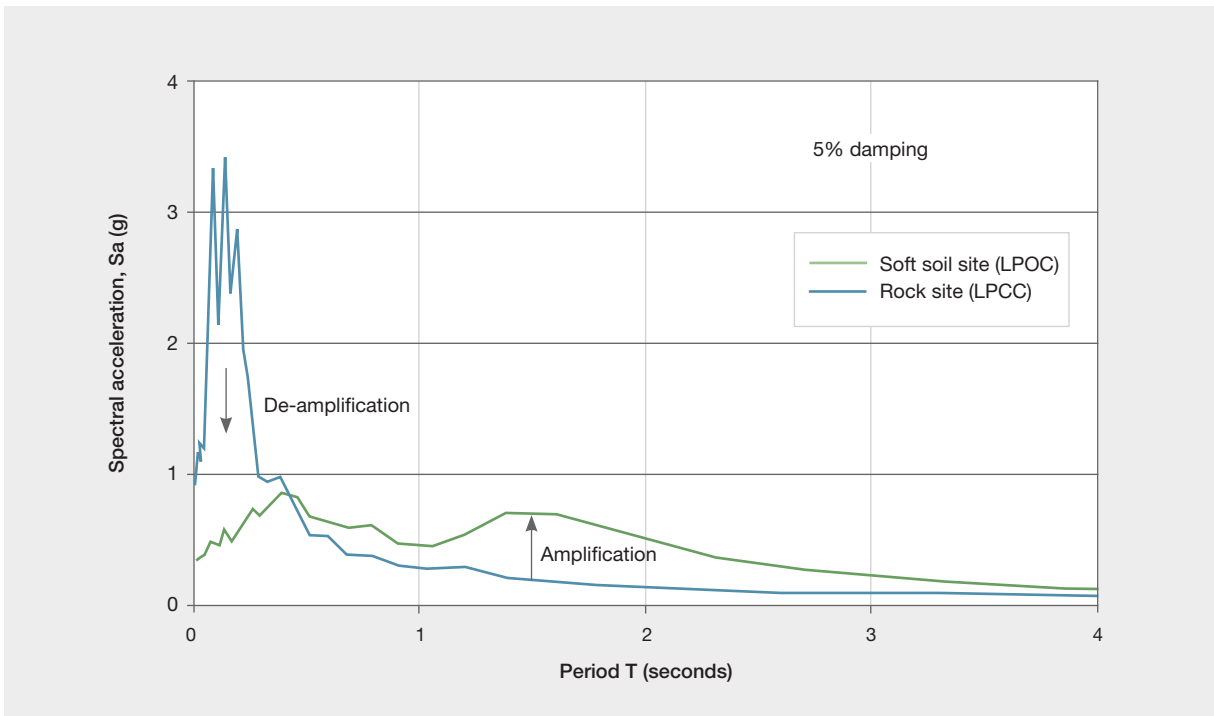

Figure 3(a): Acceleration response spectra for the February 2011 earthquake measured at a rock site and a soft soil site that are close to each other in Lyttelton<sup>3</sup>

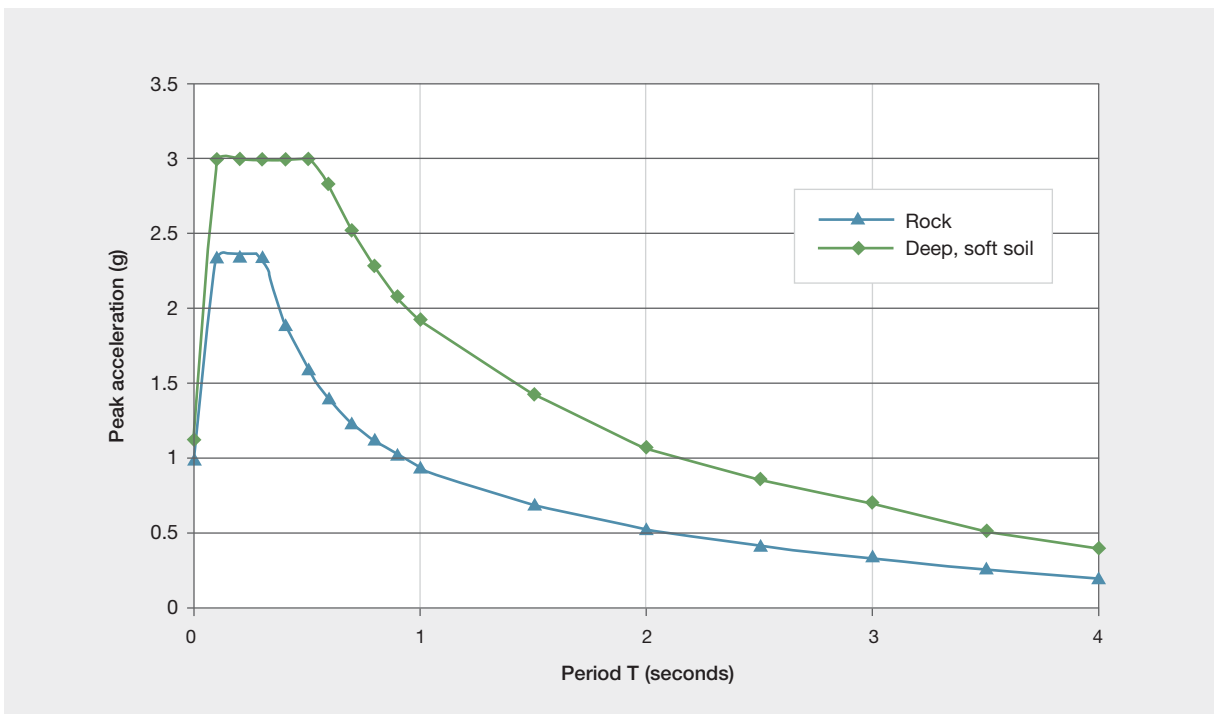

Figure 3(b): Design response spectra for alluvial soil (type D) and a rock site (type B) in NZS 1170.5

Figure 3(b) shows the corresponding rock (type B) and soft soil (type D) contained in NZS 1170.5. The distance of an earthquake from the site being considered also has a major effect on the frequency content of the ground shaking. The high-frequency vibrations in the ground decrease (attenuate) more rapidly with distance than the long-period vibrations. A consequence of this is that the response spectra for a distant earthquake, such as an Alpine Fault earthquake felt in Christchurch, will be very different from the corresponding spectra for the recent Christchurch earthquake series. NZS 1170.5 recognises the influence of soil type on response by giving four different spectra shapes: for rock, shallow soil sites, deep or soft soils and very soft soils. For the Christchurch Central Business District (CBD) the appropriate soil types are deep soils and in some cases very soft soils (types D and E in NZS 1170.5).

Figure 3(b) shows that for buildings with a natural period of two seconds the design peak ground accelerations on deep alluvial soils are about twice as high as on a rock site.

### 3.2.3 Ductile behaviour

As previously noted, the majority of modern multi-storey buildings are designed to respond in a ductile manner in the event of a major earthquake. The level of ductility, or more accurately displacement ductility, is measured by the structural ductility factor,  $\mu$ . This value is taken as the ratio of the peak displacement that can be reliably sustained without significant strength loss to the displacement where significant inelastic deformation starts to occur, as shown in Figure 1(c).

Analysis of a large number of SDOF structures indicates that the peak displacement achieved by ductile structures is generally of a similar magnitude to that sustained by an elastically responding structure with the same initial period of vibration. This “equal displacement concept” is extensively used in structural design codes. It does not apply to structures with short periods of vibration. In NZS 1170.5 the equal displacement concept is assumed to apply for structures with fundamental periods of 0.7 seconds or more for all soil types, except type E (very soft) soils, where the corresponding limit is 1.0 second. For structures with fundamental periods less than these values the lateral displacements exceed the corresponding deflections sustained by the elastically responding structure. NZS 1170.5 defines the relationship that can be used for design between the elastic displacement and ductile displacement for structures where the period is less than these limits.

As shown in Figure 4, allowing the structure to behave in a ductile manner in a major earthquake has a number of major advantages, namely:

1. Lower strengths are required, reducing in construction cost.
2. There is more freedom in the architecture of the building, enabling greater clear floor spans to be used with smaller beams, increased spacing of columns, etc.
3. A ductile building is tough in an earthquake and can generally withstand earthquakes considerably greater than design level (ULS) without collapse.
4. A ductile structure generally gives warning well before collapse occurs by opening up wide cracks in reinforced concrete structures and sustaining high displacements in steel and concrete members.
5. Non-ductile buildings give no warning of collapse and generally have less reserve capacity to sustain earthquakes greater than design level without collapse.

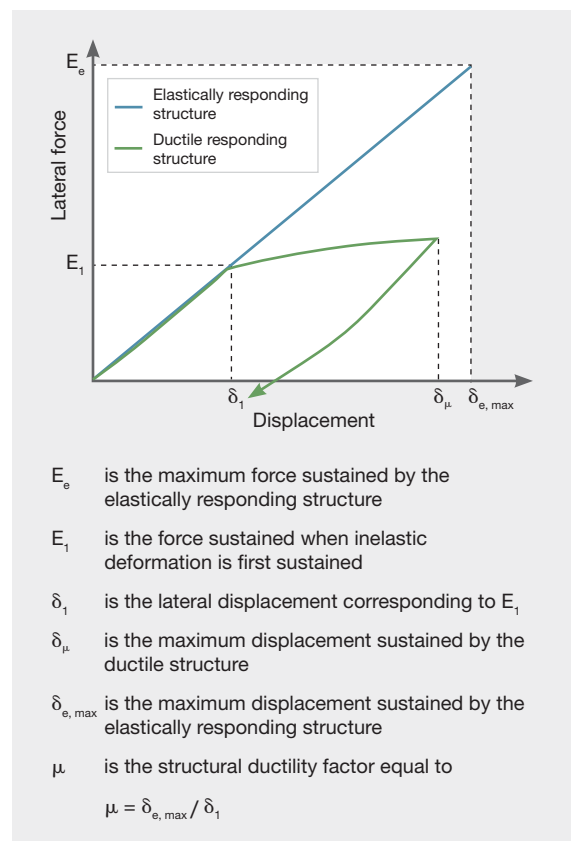

Figure 4: Structural ductility factor

### 3.2.4 Multi-degrees of freedom

Most structures can vibrate in a number of different mode shapes, as shown in Figure 5. The main, or fundamental mode, accounts for the majority of displacement. However, higher modes can have a significant influence on structural actions in parts of the structure and on the magnitude of inter-storey deflections.

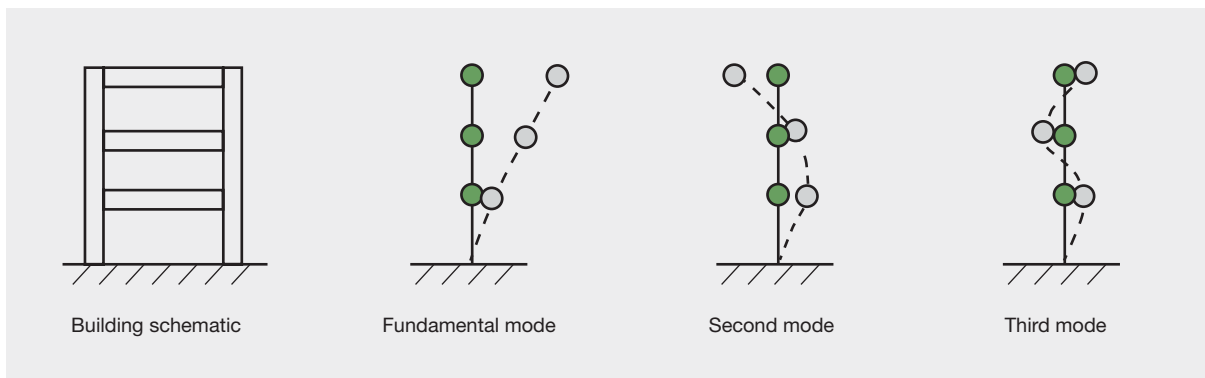

Figure 5: Higher mode shapes of deformation

Where the mass is eccentric from the centre of lateral stiffness and/or force resistance, a torsional response can occur giving rise to torsional modes of deformation. This arises predominantly in buildings that are irregular in plan. NZS 1170.5 requires allowance to be made for torsional response in all structures. This can arise from small differences in the stiffness and strength of members, non-uniform disposition of live and dead loads in the building or a component of torsional rotation in the ground motion. Ideally, buildings should be designed to minimise torsional response in earthquakes as this can cause rotation to occur about the centre of lateral resistance, which has the effect of increasing the displacements applied to structural elements located at a distance from the centre of rotation. It is the magnitude of the imposed displacement that is the principal cause of failure of structural elements. Consequently, one of the aims in seismic design is to minimise rotation of buildings caused by torsion, as this greatly improves the building's seismic performance.

### 3.2.5 P-delta actions

When gravity loads are displaced laterally, additional bending moments (referred to as P-delta actions) are induced, causing the deflection to increase further. When a structure exceeds its yield strength, P-delta actions cause the displacement to increase predominantly in one direction, with subsequent inelastic load cycles. It follows that P-delta actions tend to be more critical in major earthquakes that have a long duration of shaking and in structures that have been designed with a high level of ductility.

One way to envisage P-delta actions is to separate the two basic requirements of a structure. The first is to support the gravity loads and the second is to provide lateral resistance. In general both of these functions are resisted to a greater or lesser extent by the same structural elements.

Figure 6 shows a simple structure where the two functions of supporting gravity loads and providing lateral resistance are separated. At each level in the building, pin-ended columns support the gravity load while a second cantilever column, which may be representing a frame or wall, resists the lateral forces.

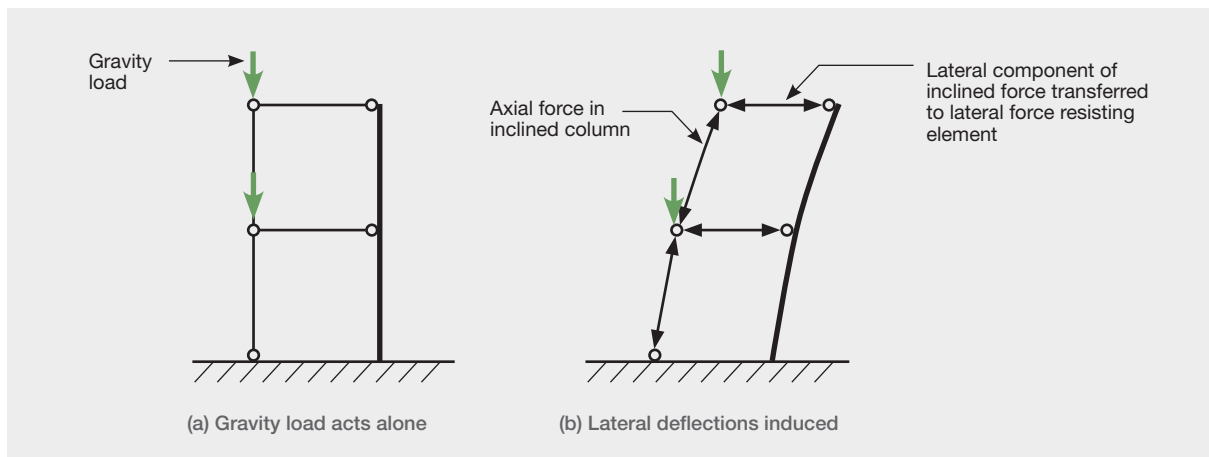

Figure 6: P-delta actions

Figure 6 shows that when lateral displacements arise in the structure the pin-ended columns supporting the gravity loads are displaced. To restrain the pin-ended column in its deflected shape, lateral forces are transmitted from it to the lateral-force-resisting structural component. This increases the bending moments and shear forces in the lateral-force-resisting structure and consequently there is a further increase in displacement associated with P-delta actions. If the lateral-force-resisting system develops plastic hinges in an earthquake the lateral stiffness is temporarily reduced. This can result in a significant increase in displacement, the magnitude of which depends on the duration of the lateral seismic force acting in that particular direction. As the inelastic displacement is not necessarily recovered when the lateral force reduces or changes direction, subsequent inelastic cycles can cause the structure to progressively deflect in the same direction. For this reason P-delta actions tend to be more critical in earthquakes where the ratio of the duration of strong ground motion divided by the fundamental period of the building is high. NZS 1170.5 has design rules to counter P-delta actions, which require additional strength to be added and allowance made for additional deformation caused by these actions.

### 3.2.6 Capacity design

A building that can sustain its strength well beyond the stage where yielding and structural damage is initiated (i.e., a ductile building) has major advantages over a brittle building, which loses its strength suddenly and is in danger of collapsing at a displacement close to that where the damage was initiated.

Capacity design is a process that has been developed to ensure that in the event of a major earthquake ductile behaviour can occur and brittle failure modes are suppressed. This is achieved by designing the structure so that inelastic deformation is confined to selected locations, known as potential plastic hinges. To achieve this objective, all the structural elements outside the potential plastic hinges are designed to have a strength that is greater than the structural actions (bending moments, shear forces, etc.) that can be transferred to them by the plastic hinges. The plastic hinges limit the magnitude of the seismic forces in the structure and ensure that ductile behaviour is maintained.

The steps involved in capacity design are as follows:

1. Identify the location of potential plastic hinges required to give the building a potential ductile performance. This step is illustrated in Figure 7(a). In moment resisting frame structures potential plastic hinges are generally located at the base of the columns and in the beams. This enables the structure to deform by what is referred to as a beam sway mechanism, as shown in Figure 7(b), spreading the inelastic deformation over the height of the building. The column sway mechanism shown in Figure 7(c) concentrates the inelastic deformation in one storey. In multi-storey buildings, where a column sway mechanism develops, high rotations are induced in the columns in order to sustain the necessary displacement. As the rotational capacity of plastic hinges is limited, these high rotations can cause premature failure and hence non-ductile behaviour. In structural walls the potential plastic hinges are generally designed to form at the base of the walls.

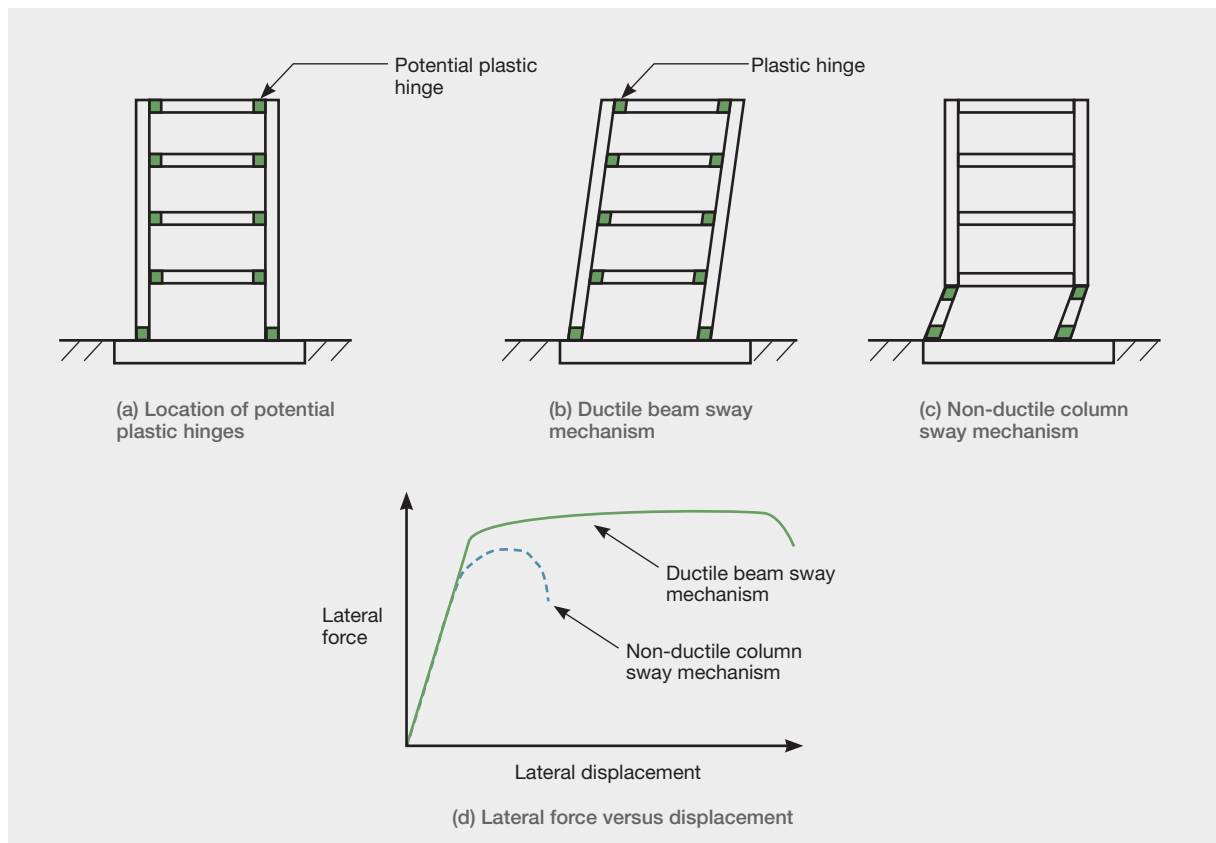

Figure 7: Ductile and non-ductile sway

2. Structural analyses are carried out to determine the minimum design strengths required in the potential plastic hinge regions to satisfy the serviceability and ultimate limit state requirements. The design strengths are taken as the nominal strengths multiplied by a strength-reduction factor. As noted below, the nominal strength is a conservative estimate of the likely strength.
3. Potential plastic hinge zones are detailed to provide the required design strength. After this the over-strength of each potential plastic hinge region is calculated, based on the structural details actually used in the plastic hinge and on the basis that the materials have their upper characteristic strength values. This over-strength is the maximum likely strength of the plastic hinge region. For reinforcement or structural steel members the upper characteristic strength is such that on average 95 per cent of the material will have a yield strength less than this value. The assumed maximum stress in the reinforcement or structural steel member is further increased to allow for strain hardening. In some cases where high axial load levels act it is necessary to allow concrete strengths greater than those assumed in design and for a further increase in strength where the concrete is confined.
4. The combination of structural actions that give the most critical actions that may need to be resisted by each plastic hinge is assessed and these values are used to determine the maximum structural actions that can be induced into the regions of the structure outside the potential plastic hinges.
5. The remainder of the structure (outside the potential plastic hinge zones) is designed to have a nominal strength greater than the maximum structural actions that can be induced in it by the plastic hinges.

The nominal strengths in flexure, axial load, shear and torsion are calculated assuming the materials have their lower characteristic strengths, which are based on the calculation that only five per cent of the material (steel, concrete, etc.) will on average have strengths lower than the assumed value. For the ULS the strength-reduction factor is always less than 1. For reinforced concrete the ratio of average strength to nominal strength is generally in excess of 1.15 and the strength-reduction factor for flexure is 0.85. Consequently the average strength at or close to first yield of the reinforcement is achieved with a high level of certainty. If allowance is made for increase in strength caused by strain hardening of reinforcement the average peak strength increases to about 1.5 times the design strength.



This process ensures that the design strength is achieved with a high level of certainty. This, together with other conservative assumptions regarding inelastic deformation limits, gives protection against collapse for earthquakes considerably in excess of design levels corresponding to the ultimate limit state design actions.

Proper application of capacity design principles should ensure that the structure will behave in a predictable ductile way in the event of a major earthquake.

## 3.3 Analysis of seismic actions

### 3.3.1 Introduction

There are three different types of analysis that can be made to assess seismic design actions for new buildings or to assess the likely performance of existing structures: force-based design, displacement-based design and time history analysis.

Force-based design methods have been extensively used for many decades and are well established and accepted in many structural design codes of practice. Displacement-based design methods are more recent. The initial steps in this approach were made about 30 years ago, but it is only in the last decade and a half that displacement-based approaches have been established and used in practice. At present, displacement-based methods are not as widely accepted as force-based methods.

Both methods have advantages and disadvantages. Force-based design is familiar, widely accepted and there is plenty of software available. Displacement-based design has the advantage of concentrating at the outset on limiting seismic-induced displacements to an acceptable level. The magnitude of inelastic deformation associated with ductile behaviour is a major cause of damage. Consequently a design method using this approach starts by considering the level of damage that is acceptable in a given situation. This can help a designer select more rational structural arrangements and strength distributions in some situations.

Both force and displacement-based methods of analysis rely on response spectra (see section 3.2.2). In NZS 1170.5, the design response spectrum for a building is specified in terms of:

1. A specified spectral shape factor,  $C_h(T)$ , which depends on the soil type. For the Christchurch CBD this is deep alluvial soils, type D in NZS 1170.5.
2. The seismic hazard factor for the region, which for Christchurch is currently 0.3.
3. The return period,  $R$ , which relates the magnitude of the design actions to the earthquake considered at the design limit state. As noted earlier, the ULS for normal commercial buildings has a value of 1 and corresponds to a return period of 500 years.
4. A near fault factor that allows for increased seismic actions for buildings located close to a major fault. These major faults are listed in Table 3.6 of NZS 1170.5. As none of these are close to Christchurch this coefficient is neutral and it has a value of 1.

The application of these factors gives the design response spectrum for the Christchurch CBD for type D soil conditions shown in Figure 8.

In the following sections the basic concepts of force-based and displacement-based design are described. In the interests of brevity, many of the details have been omitted.

### 3.3.2 Design spectra

Figure 8(a) shows a response spectrum for a Christchurch site for normal commercial buildings on soil type D for the ultimate limit state. The peak design lateral force on an elastic SDOF structure is equal to the weight of the structure multiplied by the lateral force coefficient,  $C(T)$ , corresponding to the fundamental period,  $T$ , of the structure (see section 3.2.2).

With reference to Figure 8(a), the design lateral force for a SDOF structure with a fundamental period of 1.5 seconds is 0.43 multiplied by its weight. Figure 8(b) shows the corresponding displacement for the SDOF structure as 0.25m. In Figure 8(c) the relationship between the lateral force coefficient and displacement is shown. The first two spectra are used in force-based design of new buildings. In displacement-based design the values are adjusted to allow for different damping levels.

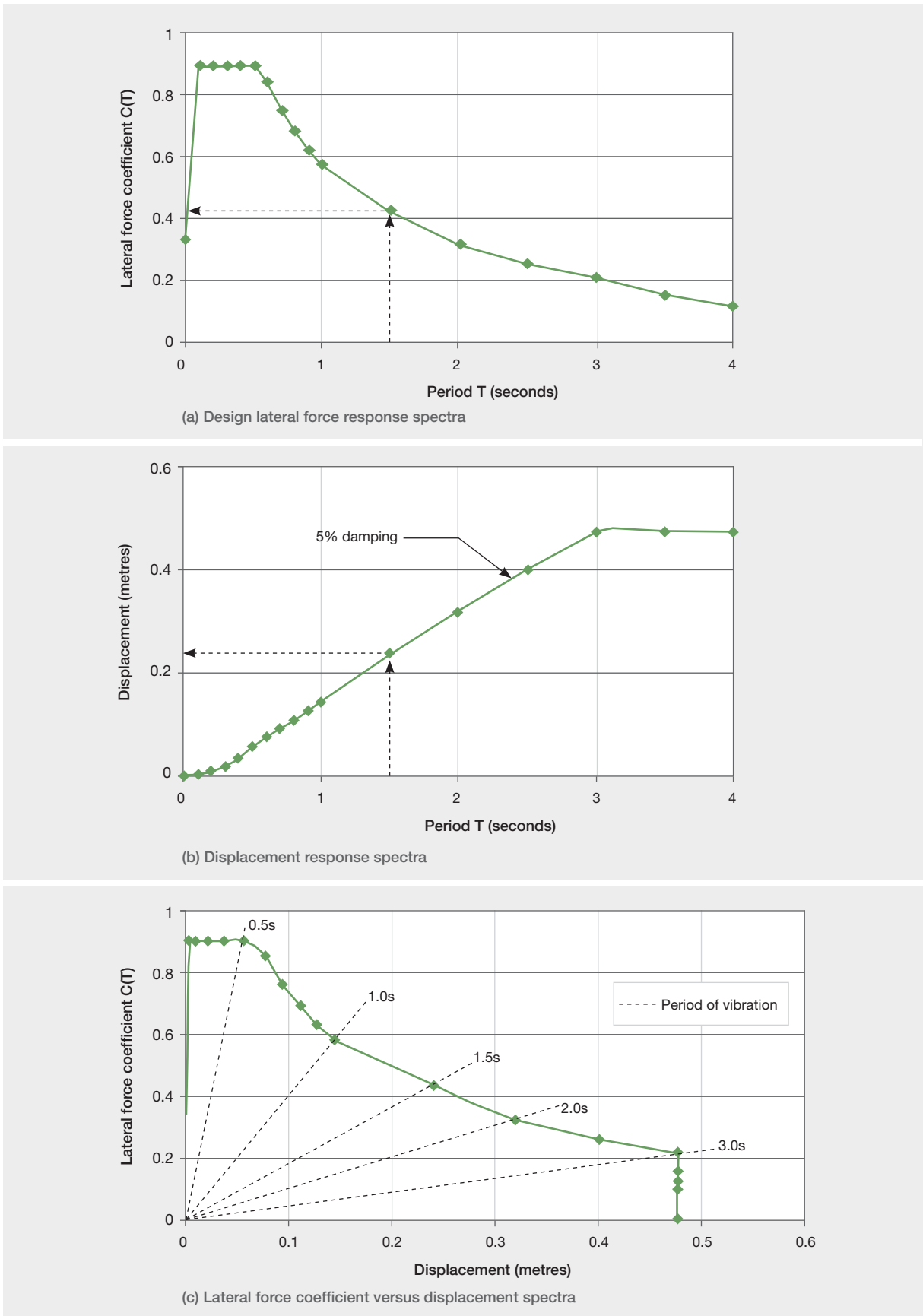

Figure 8: Elastic design response spectra for normal commercial buildings in Christchurch

### 3.3.3 Force-based design

There are two different force-based methods of design in NZS 1170.5, namely equivalent static and response spectrum.

#### 3.3.3.1 Equivalent static method

The equivalent static method is the simpler of the two. It can be used on low-rise structures and on reasonably regular multi-storey buildings provided their fundamental period does not exceed two seconds. It is based on the assumption that the building will behave predominantly in its first mode. Much of the analysis necessary for this approach can be carried out by hand.

The approach relies heavily on the equal displacement concept, in which a ductile structure sustains either a peak displacement equal to that sustained by an equivalent elastic structure if the period exceeds the critical value or where the period is less than the critical value, the peak displacement is taken as the product of a coefficient and the elastic displacement. The coefficient varies with period and values are given in design codes.

In practice, the ductile inelastic deformation dissipates energy (effectively increasing the level of damping) but at the same time it increases the effective period of vibration. There are two effects here. First, if the change in effective period is ignored, the damping reduces both the lateral seismic forces and the displacement demand. However, allowing for the change in effective period increases the displacement demand. These two effects generally tend to cancel each other out, as indicated by the general validity of the equal displacement concept. In displacement-based design the effect of an increase in effective period and damping are individually assessed.

The steps involved in analysing a building with force-based design can be outlined as follows:

1. Developing an analytical model of the building in which the structural elements are all represented by stiffness values that correspond to the response of the structure just prior to the stage where inelastic deformation is induced.
2. Analysing this structure to find its fundamental period of vibration.
3. Finding the lateral forces that would act on the SDOF structure that has the same fundamental period. With reference to Figure 8(a), if the fundamental period of the building was 1.5 seconds the equivalent force would be  $0.43 W_t$ , where  $W_t$  is the weight of the structure.
4. If the structure is ductile, the design base shear is taken as the value noted above but divided by a coefficient,  $k_u$ , where for a building with a period greater than 0.7 seconds  $k_u$  is taken as equal to the structural ductility factor,  $\mu$ . This reduction in design force is based on the equal displacement concept. The value is further reduced by the structural performance factor,  $S_p$ , which was introduced to allow for a number of factors that are not easily quantified and are not directly accounted for in the design process. Hence for a building with a fundamental period of 1.5 seconds, which has been designed assuming a structural ductility factor of 4.0 and the corresponding  $S_p$  factor of 0.7, the design base shear force,  $V$ , is equal to  $0.0753W_t$ .
5. The design base shear is equal to the sum of the design lateral forces.
6. The lateral force coefficient acting at each level is theoretically equal to the acceleration at that level relative to the ground. For simplicity, it is generally assumed that the acceleration at any height is proportional to the height above the ground. Hence the design lateral forces are found by multiplying the weight at each level by the lateral force coefficient, which has a linear variation proportional to height. However, one modification is made whereby eight per cent of the base shear force is added to the lateral force at the highest level, with the remaining 92 per cent being distributed on the basis of the lateral force for each height. This modification is made to allow for actions associated with the second and higher modes of deformation.

The equation for the lateral forces is given by:

$$F_i = 0.92V \frac{W_i h_i}{\sum (W_i h_i)} + F_t$$

where  $F_i$  is the lateral design force at level  $i$ ,  $V$  is the base shear force,  $W_i$  is the weight and  $h_i$  is the height at the level,  $i$ , being considered.  $\sum (W_i h_i)$  is the sum of the product of the weight and the height for all levels and  $F_t$  is equal to zero for all levels except the highest where it is equal to  $0.08V$ .

The set of forces defined above is applied to the analytical model. This gives a set of bending moments, shear forces and axial loads acting in the structural members together with the lateral deflection at each level. These sets of values are scaled to allow for torsional actions that may be introduced into the building. These torsional actions can arise as a result of non-uniform ground motion, irregularities in the distribution of load and the eccentricity of the centre

of lateral force resistance from the centre of mass and hence seismic force. The displacements are increased to allow for the associated inelastic deformation. If the inter-storey drift limits are within the acceptable range a further analysis is carried out for P-delta actions and the inter-storey drifts re-checked. If the deflections exceed permitted limits the member sizes and associated stiffness values are modified and the process is repeated.

Once the design actions have been calculated, capacity design is undertaken to ensure the buildings will behave in a ductile manner in a major earthquake. To complete the design, the design forces that need to be accommodated to ensure that the different structural elements are tied together, are calculated from criteria given in the design standards.

### 3.3.3.2 Modal response spectrum method

The modal response spectrum method is a computer-based approach. As with the equivalent static method, an analytical model of the building is developed.

The computer programme determines the different modes of vibration of the structure, finding the period and deformed shape of each mode together with the effective mass of each mode. On the basis of the response spectrum the lateral force coefficient for each mode is found and the associated structural actions are determined.

Once the structural actions in each mode have been assessed, the next task is to combine the actions. Because the modes all sustain their peak displacements and structural actions at different times, the values cannot be simply added. There is a variety of techniques available for deriving appropriate values for design purposes. The simplest of these is to take the square root of the sum of the squares of each structural action at the point being considered. There are other more comprehensive techniques available.

Response spectrum analysis is a more advanced approach than the equivalent static method in that it handles torsional actions more realistically and makes a more rational allowance for higher mode effects. For this reason, this approach is used where the equivalent static method is not appropriate because of irregularities in the structure or because higher mode effects are expected to play an important role in the structural behaviour of the building.

There are some basic problems with the modal response spectrum method of analysis. If torsional modes of response are ignored, the sum of all the masses associated with displacement in one direction

equals the total mass of the structure. However, many of the very short period modes contribute little to the total mass. Consequently many of the higher mode contributions can be ignored. To find the number of modes that need to be included in an analysis, starting at the fundamental mode the effective masses in each mode are added until the total is equal to or greater than 90 per cent of the total mass of the structure. The 90 per cent limit is widely accepted in design codes of practice. With torsional response the sum of the effective masses in each mode no longer add up to 100 per cent of the mass of the structure. This can be important where torsional response is a major feature of the building, in that the torsional contribution can in some situations be omitted.

A further major problem arises out of the combination of the modal actions. By taking the sum of the squares, or any of the other methods of combination, the sign of the action (that is, positive or negative bending moments, shears or displacements) is lost. A consequence of this is that the bending moments are no longer consistent with the shear forces or deflections and hence it is not possible to use the results of a response spectrum modal analysis to track loads. Where this is required it is necessary to use the results of an analysis for a single mode.

The modal response spectrum analysis assumes elastic behaviour. In design it is necessary to modify the predicted values to allow for inelastic behaviour and for P-delta actions in a similar way to that used with the equivalent static method.

Once the analysis has been completed and the structure is detailed to satisfy strength and stiffness requirements, capacity design is carried out to ensure that the building will behave in a ductile manner in the event of a major earthquake. It is essential to realise that buildings do not respond to major earthquakes elastically and any elastic analysis only gives a guide to performance. For this reason it is essential that capacity design is carried out if any appreciable ductility has been assumed in the design.

As with the equivalent static method, the design forces required to tie the structural components together are not given by the analysis and it is necessary to follow criteria given in the design standards to assess these actions.

### 3.3.4 Displacement-based design

As noted previously, the initial steps in the development of displacement-based design were made three decades ago. However, it is only in the last decade that the method has been used to any appreciable extent. Here only one version of this approach, namely Direct Displacement-Based Design (DDBD) will be described. The objective of the method is to base the design on the displacement that can be safely sustained for the limit state being considered. This has the advantage of focusing on displacement, which is the principal, though not sole, cause of structural damage. Focusing on displacements at the start of an analysis can in certain cases be advantageous in helping to identify how the strength to resist lateral seismic forces can best be distributed. The ability to allow directly for the influence of damping and period shift on strength and displacement demands can also be a major advantage when designing buildings using new technologies such as Precast Seismic Structural Systems (PRESS), where the structure does not sustain structural damage and energy is dissipated by specifically designed structural elements.

The philosophy of DDBD is based on the fundamental inelastic mode of response and can be divided into four components, as shown in Figure 9. For a multi-storey building it begins by idealising the structure as a SDOF system, which has a characteristic force-displacement response into the inelastic range. The effective mass and height of the equivalent SDOF simulation can be simply calculated using weighted formulae.

The design displacement limit can be calculated at the start of design without needing to know the strength or initial stiffness. For the ultimate limit state the maximum displacement is defined by the displacement associated with the permissible material strain limits for structural elements or the limiting permitted inter-storey drift.

The level of displacement ductility varies with different limit states. There are relationships between the displacement ductility and equivalent viscous damping that can be found in the literature: Priestley et al<sup>4</sup> give suitable equivalent viscous damping ratios for the various structural forms and displacement ductility levels, as shown in Figure 9(c). NZS 1170.5 contains design spectra based on five per cent equivalent viscous damping for different soil types. In displacement-based design the designer requires response spectra with equivalent viscous damping levels associated with the limit state being considered and assumed ductility level. The required spectra for defined equivalent viscous damping levels can

be obtained by multiplying the five per cent damped spectrum by an appropriate factor,  $F$ . A number of different factors have been proposed but one recommended for sites that are not close to major fault lines is:

$$F = \left( \frac{7}{2 + \xi} \right)^{0.5}$$

In this equation  $\xi$  is the equivalent viscous damping level.

The design process is illustrated in Figure 9. It follows six basic steps:

1. An equivalent static SDOF structure is derived from the proposed building, as shown in Figure 9(a).
2. A limiting displacement,  $\Delta_u$ , is selected based on limiting material strains or inter-storey drift.
3. Based on the properties of the proposed building, the displacement at first yield of the SDOF structure  $\Delta_y$  is assessed. The ratio of  $\Delta_u/\Delta_y$  gives the ductility. From an assumed strength,  $F_n$ , and an appropriate strain hardening stiffness ratio,  $\gamma$ , the secant stiffness,  $K_e$ , can be found as shown in Figure 9(b).
4. From the displacement ductility the equivalent of viscous damping can be found as shown in Figure 9(c).
5. The fundamental period and the equivalent viscous damping allows the peak displacement to be found as shown in Figure 9(d). This value can now be compared to the initial displacement.
6. The process is repeated by changing the assumed strength,  $F_n$ , until convergence is obtained.

As with the equivalent static method, the base shear is used to determine the distribution of strength over the height of the structure. Further adjustments are made to allow for P-delta actions and this is followed by capacity design to provide protection against higher mode actions.



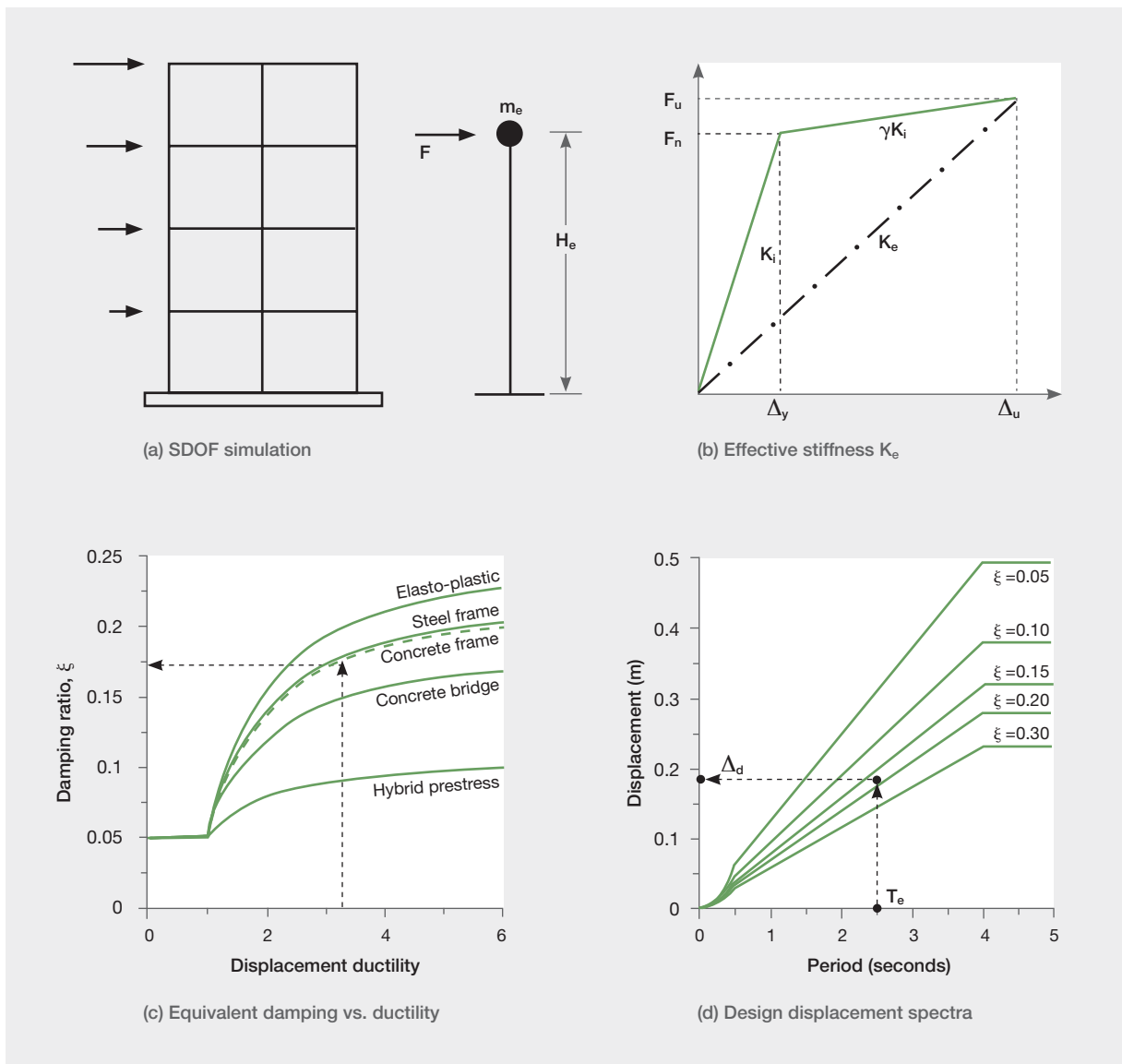

Figure 9: Fundamentals of direct displacement-based design (adapted from Priestley<sup>4</sup>)

As with force-based principles, the DDBD method is based on a range of assumptions, which are simplifications of a structure's behaviour and dynamic characteristics. In DDBD there are concerns relating to the level of equivalent viscous damping and the secant stiffness of the SDOF system, as well as the idealisation of a truly Multi Degree of Freedom (MDOF) structure as a SDOF and the implicit assumptions that are made in the deflected shape profile of the structure.

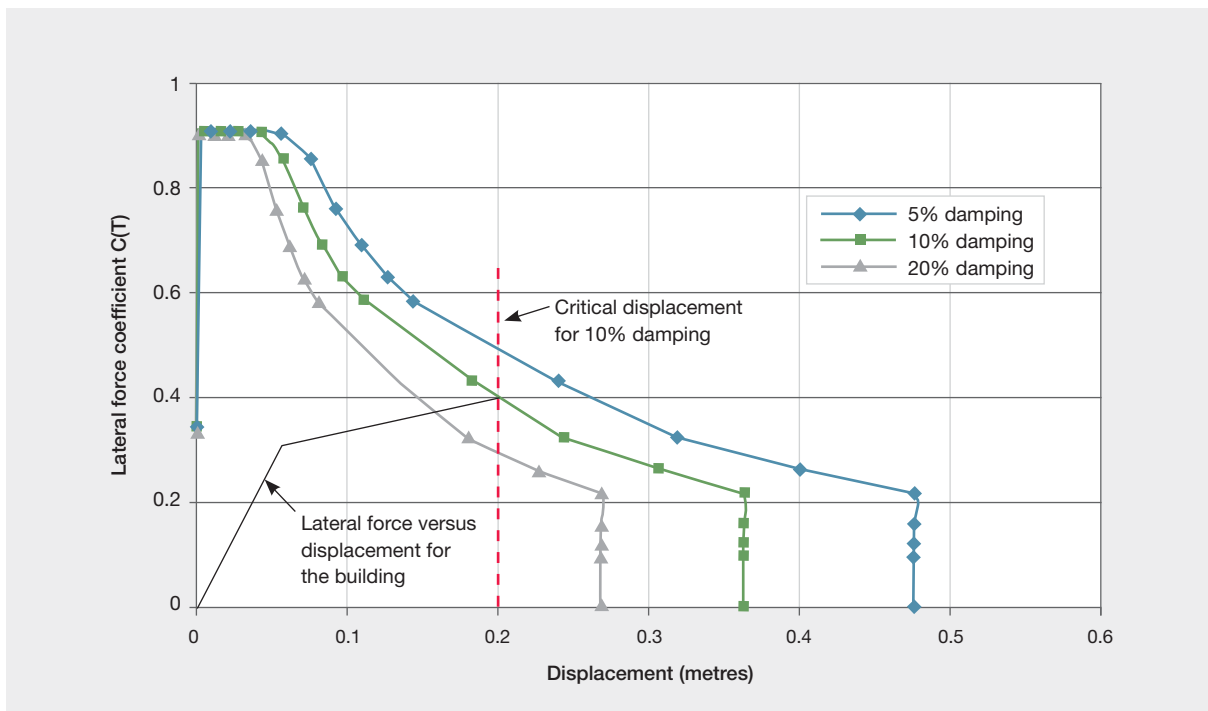

Figure 10: Seismic performance of existing structures with displacement-based assessment

The relationship between the lateral force coefficient and displacement shown in Figure 10 can be used to assess the seismic performance of existing structures. For an existing structure it is possible to assess the yield strength and the strain hardening ratio together with the displacement at first yield. With this information it is possible to plot the relationship between lateral force and displacement. The point at which this curve intersects the curve for a given damping defines the magnitude of the displacement that the structure must be able to sustain (Figure 10). In making this assessment it is essential to make allowance for either increased displacements or reduced lateral strength caused by P-delta actions.

### 3.3.5 Time history analysis

An analytical elastic model of the structure is developed. This is then analysed by subjecting the structure to a number of notional earthquake ground motions. Rules are given in NZS 1170.5, which identify the earthquake characteristics that must be used and how they are to be scaled so that they are consistent with the design response spectrum.

The elastic time history analysis approach has the advantage that it avoids the problem inherent in the modal response spectrum method of combining the modal actions. However, there are several inherent problems with this elastic time history analysis when

it is used for ductile structures. The analysis does not allow for the influence of inelastic actions on the deflected shape profile or on P-delta actions. Consequently, separate allowance needs to be made for these effects. In addition, care is required in selecting the appropriate level of damping and the way in which it is included in the analysis, as this can have a significant influence on the predicted actions. Having obtained the structural actions from the analyses, there remains the problem of how these elastic values can be reduced to values appropriate for ductile structures. The elastic time history method is appropriate for assessing serviceability limit state conditions and in structures where inelastic deformation is not anticipated in the design limit state being considered. It may also be used as a method of assessing the likely required strengths for a model used for an inelastic time history analysis.

Inelastic time history analyses involve modelling the elastic and inelastic response of the building elements. As with elastic time history analyses, a series of earthquake ground motions, suitably scaled so that they are consistent with the design response spectrum, is applied to the analytical model. This method of analysis is appropriate for use in the design of special structures and for assessing the likely seismic performance of existing structures. The use of this method of analysis involves specialist knowledge and a considerable time commitment.

## 3.4 Different structural forms in buildings

### 3.4.1 General

There are a number of common structural forms used to provide resistance to lateral forces from wind or earthquakes. They include structural walls, moment resisting frames, eccentrically braced frames and concentrically braced frames. All may be referred to as lateral-force-resisting elements. In all cases the floors and sometimes the roofs are designed to hold the building together and transmit inertial induced forces to the lateral force resisting elements. To sustain these actions the floors act as diaphragms. For this reason floors are often referred to as diaphragms.

Different structural elements that are widely used to provide lateral force resistance are described in the following paragraphs. A number of advanced structural forms or structural components that may potentially be used to improve the seismic performance of new buildings, or in some cases existing structures, are described in Volume 3 of this Report.

### 3.4.2 Moment resisting frames

Moment resisting frames are made up of beams and columns in an arrangement such as that shown in Figure 11. These are designed to resist lateral forces caused by earthquakes. Potential plastic hinges are located in the beams adjacent to the columns and at the base of the columns. This form of construction is used with both reinforced concrete and structural steel.

Often moment resisting frames are located around the perimeter of the building, where greater beam and column sizes can be accommodated without increasing storey heights. More slender beams and smaller columns may be used in the interior of the building to support the floors and transmit most of the gravity loads to the foundations.

### 3.4.3 Eccentrically braced frames

Eccentrically braced frames are constructed from structural steel members. They are generally located in perimeter frames or in the structural elements surrounding stairs and lift shafts.

The beams are braced with diagonal members, as shown in Figure 12.

When critical lateral forces are applied to the frame, high shear forces are induced in the active link of the beam, causing the link to yield in shear. This arrangement has been found to be capable of sustaining repeated inelastic deformation provided the active link is adequately reinforced with web stiffeners to prevent premature buckling failure. It has been found to be a reliable method of providing ductility in buildings.

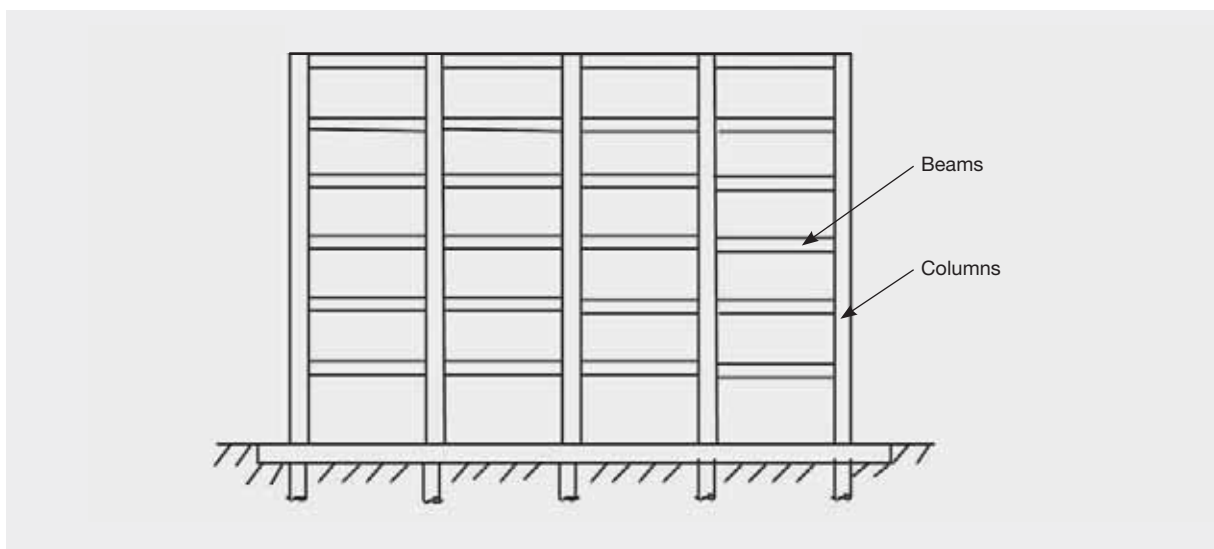

Figure 11: Moment resisting frame

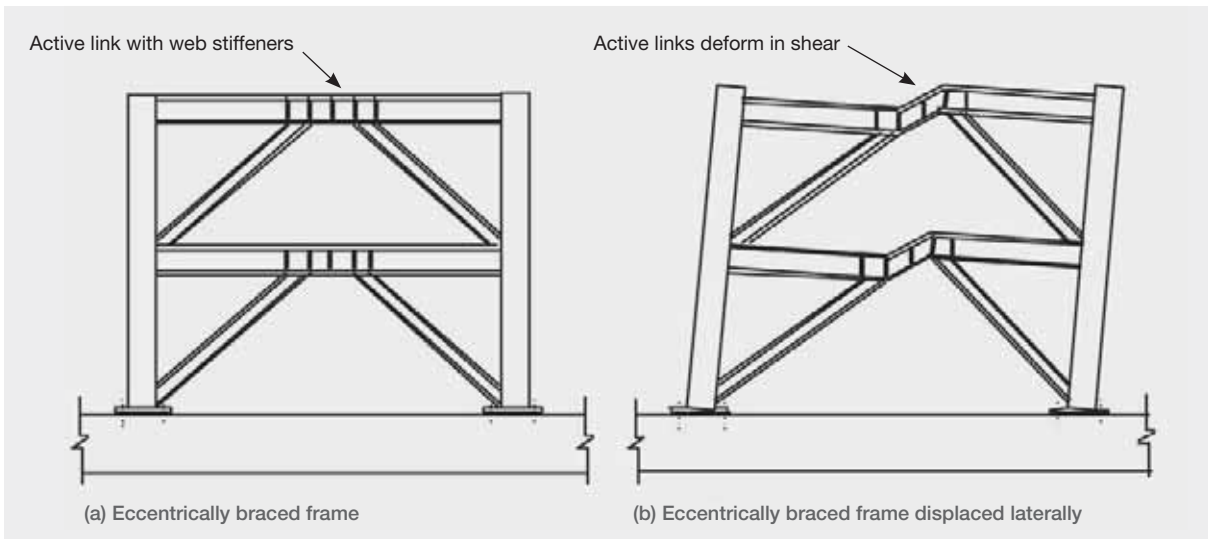

Figure 12: Eccentrically braced frame

Generally only one or two bays in each perimeter frame are eccentrically braced, which leaves room for windows and doorways in bays that are not braced.

### 3.4.4 Structural walls

Structural walls, often referred as shear walls, are extensively used to provide lateral resistance for wind and earthquake actions. For seismic resistance, structural walls are generally designed with potential plastic hinges located at their base. This limits the region where special detailing of reinforcement is required. The detailing enables the plastic hinge to sustain the inelastic deformation associated with rotation in this region. The plastic hinge also limits the structural actions that can be induced into the higher regions of the wall.

Coupled shear walls are used extensively (Figure 13). The basic concept is to proportion the wall and coupling beams so that in a major earthquake plastic hinges form first in the coupling beams and then at the base of the walls. It has been found that coupling beams designed with diagonal reinforcement can sustain extensive repeated inelastic displacements, so they provide good ductile behaviour. The coupling beams, when reinforced with diagonal reinforcement, deform in a shear-like mode. This form of structure limits the damage zone to regions that can be relatively easily repaired after a major earthquake.

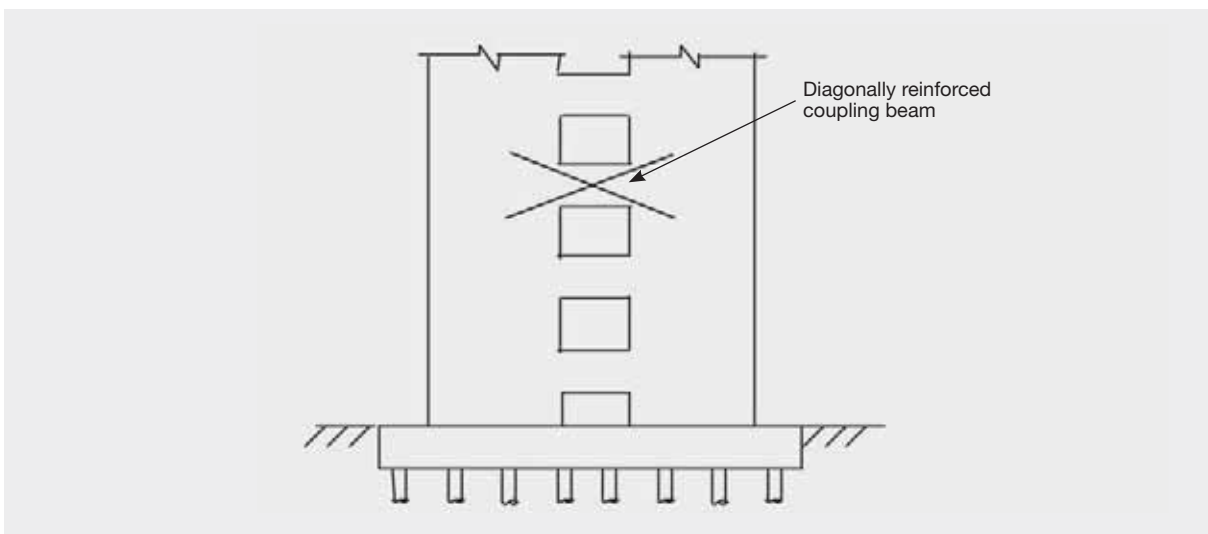

Figure 13: Coupled structural wall

### 3.4.5 Concentrically braced frames

Concentrically braced frames are used extensively in low-rise steel industrial buildings. Diagonal bracing spanning between adjacent columns transfers forces in the structure to the foundations.

Where a high lateral stiffness is required, for example in the retrofit of some masonry buildings, K braced frames (Figure 14) may be used.

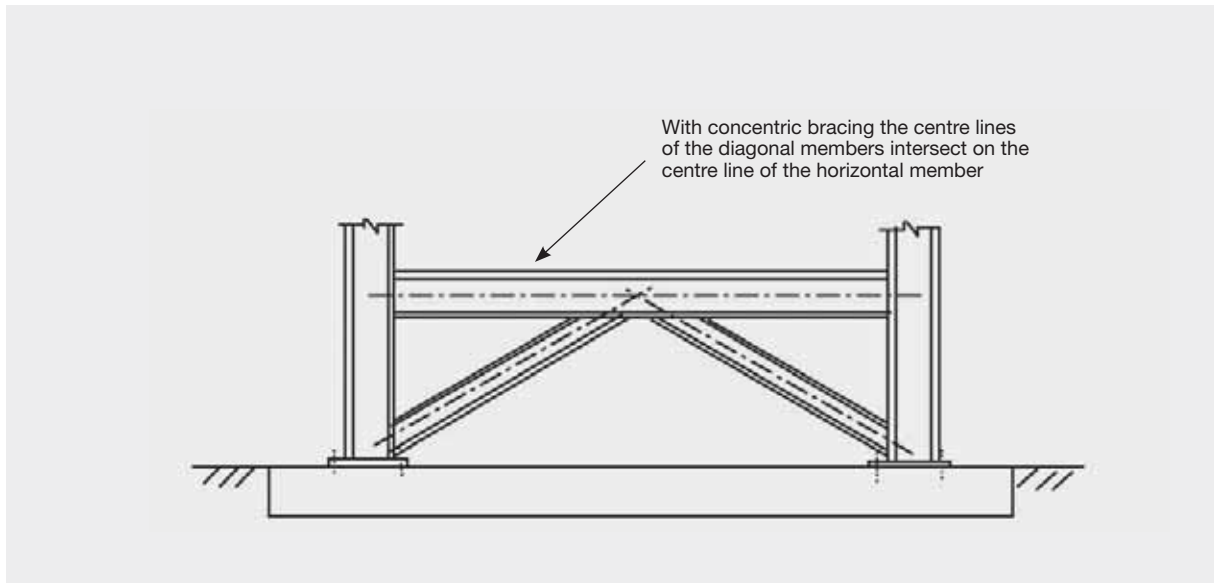

Figure 14: Concentrically braced frame

### 3.4.6 General building forms

Many buildings contain a mixture of the structural elements described above. A common form is to have a core of structural walls around the stairwells and liftshafts. These provide a high proportion of the lateral seismic resistance. Surrounding these walls are arrangements of columns and beams, which generally provide the resistance to gravity loads. They can also contribute as moment resisting frames to resist a portion of the lateral forces, particularly the resistance to torsional rotation. The beams and columns may be of reinforced concrete or structural steel.

Another very common arrangement is to use walls to resist seismic forces in one direction and moment resisting frames at right angles.



## References

---

1. AS/NZS 1170.0:2002. *Structural Design Actions Part 0: General Principles*. Standards Australia/Standards New Zealand.
2. NZS 1170.5:2004. *Structural Design Actions Part 5: Earthquake Actions – New Zealand*. Standards New Zealand.
3. Cubrinovski, M. and McCahon, I. (2011 August). *Foundations on Deep Alluvial Soils*. Report to the Royal Commission of Inquiry into Building Failure Caused by the Canterbury Earthquakes.
4. Priestley M.J.N., Calvi G.M. and Kowalsky M.J. (2007). *Displacement-based Seismic Design of Structures*. Pavia: IUSS Press.

# Section 4: Soils and foundations

---

## 4.1 Introduction

Under the Terms of Reference for the Inquiry into the representative sample of buildings the Royal Commission must inquire into and report on the nature of the land associated with the buildings considered. To fulfil this obligation we considered that we should develop a general understanding of the subsurface conditions in the Christchurch central business district (CBD), as well as considering the impacts of the soils on the performance of buildings on particular sites.

## 4.2 Expert advice

We commissioned the following reports:

1. "Foundations on Deep Alluvial Soils" by Associate Professor Misko Cubrinovski of the University of Canterbury and Ian McCahon<sup>1</sup>, a principal of Geotech Consulting Ltd, Christchurch, dated August 2011. This report gives a general overview of the alluvial soils underlying the Christchurch CBD and discusses liquefaction, lateral spreading and the consequential impact of the Canterbury earthquakes on foundations. The report also provides some general concepts that should be followed in designing foundations for buildings on deep alluvial soils.
2. A peer review of the Cubrinovski and McCahon report by Professor Jonathan Bray<sup>2</sup> of the University of California at Berkeley, dated October 2011.
3. "Foundation Design Reliability Issues" by Dr Kevin McManus<sup>3</sup>, a civil engineer. This report provides a largely technical discussion on the practice of foundation design in New Zealand.

The Royal Commission conducted a public hearing on these issues on 25 October 2011. The expert advisers gave evidence about the issues addressed in their reports to the Royal Commission. Nine submissions were also received from interested parties, the content of which has been considered and analysed by the Royal Commission and addressed where appropriate in this Report. Those who made submissions are listed in Appendix 3 of this Volume.

In addition, a report entitled "Geotechnical Investigations and Assessment of Christchurch Central Business District" by Tonkin and Taylor Ltd<sup>4</sup>, commissioned by the Christchurch City Council (CCC), was provided to the Royal Commission.

## 4.3 Canterbury soils

Christchurch is located on deep alluvial soils of the Canterbury plains, except for its southern edge, which is on the slopes of the Port Hills, on the remains of the Lyttelton volcano.

As discussed in section 2 of this Volume, Canterbury is situated on land that is being deformed by the oblique collision between the Australian and Pacific tectonic plates. The rate of deformation decreases with distance from the Alpine Fault to the east and from major faults in North Canterbury that branch off the Alpine Fault.

The Canterbury region is underpinned by complex inter-layered soil formations to a depth of 500 metres or more, deposited by eastward-flowing rivers from the Southern Alps into Pegasus Bay and Canterbury Bight on the Pacific coast. The Canterbury plains consist of very thick soil deposits.

## 4.4 Soils in the Christchurch CBD

The soils are highly variable both horizontally and vertically over relatively short distances, with different composition and densities of soils across small distances, as shown in Figure 1 below:

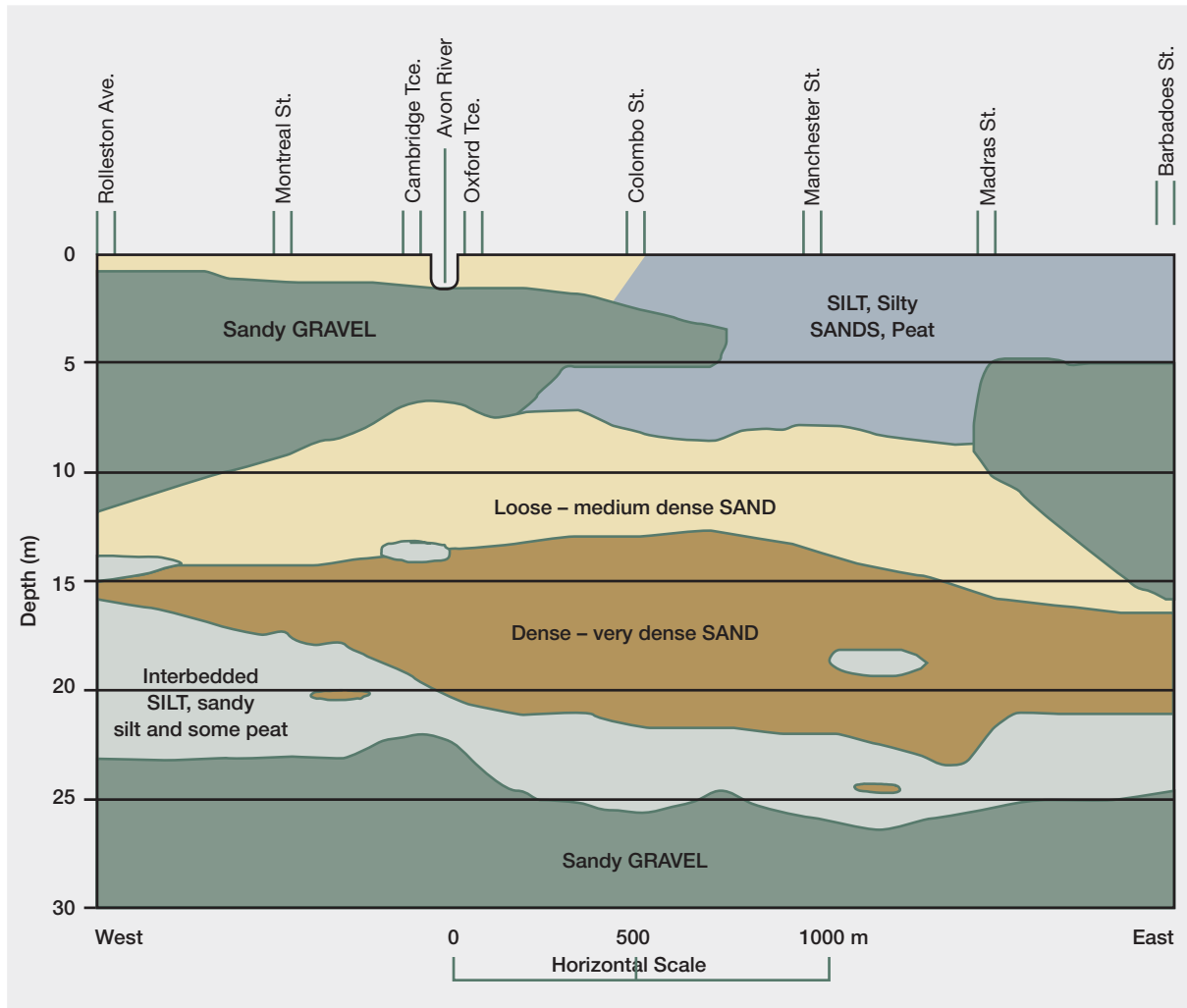

Figure 1: Subsurface cross-section of Christchurch CBD along Hereford Street (source: Cubrinovski and McCahon, August 2011, reproduced and modified from Elder and McCahon, 1990)

In the top 20–25 metres, the soils are geologically young and contain mixtures of sands, silts and peat, together with some swamp and marine deposits. As a consequence they are relatively weak and poorly consolidated. Beneath this layer are 300–500 metres of thick gravelly deposits, which are older strata that have greater strength. The water table in the CBD sits at a depth of 1–1.5 metres, which increases to about five metres to the west of the CBD. Aquifers exist in the top 25 metres. This combination of soil characteristics, aquifers and high water table increases the risk of liquefaction.

The soils in the CBD are fluvial deposits from both the Avon and Heathcote Rivers and the Waimakariri River, which is known to have flooded the area and significantly contributed to the shape and the ground conditions of Christchurch over a long period of time. Early maps show that in the 1850s, around the Avon River there were many streams and a number of areas of surface water. The old river channels have very loose soils in conditions that have a high potential for liquefaction. Cubrinovski and McCahon<sup>1</sup> note that soil behaviour and liquefaction can be influenced by previous land use and the presence of rivers and streams dating from well over 150 years ago.

The results of an extensive ground investigation commissioned by the CCC and undertaken by Tonkin and Taylor<sup>4</sup>, to evaluate the nature and variability of subsurface conditions in the Christchurch CBD and adjacent commercial areas to the south and north-east, will be held in a database available to the public. The information may be used to assess the potential impact of future large earthquakes on structures and their foundations and to assist decision making regarding land-use planning by local authorities. It should also enable geotechnical specialists to prepare concept designs for foundations and ground improvement options for future development.

The investigations carried out by Tonkin and Taylor<sup>4</sup> did not establish that there were areas in the CBD that could not be built on because of the ground conditions. However, more robust foundation design and/or ground improvement may be required<sup>4</sup> than was previously understood to be necessary. Land within 30 metres of the Avon River is the most likely to be affected by lateral spreading.

## 4.5 Role of soils in an earthquake

Cubrinovski and McCahon<sup>1</sup> identify two fundamental ways that seismic waves travelling through deep alluvial soils influence the performance of land, infrastructure and buildings during strong earthquakes.

High frequency seismic waves attenuate more rapidly with distance than low frequency waves. This causes the general shape of the response spectrum to change with the distance the seismic waves travel. The deep formations of sand, silt and gravel deposits below the Christchurch CBD amplify the long period vibrations in the seismic waves. The interaction of those waves with the relatively soft upper layers in the Christchurch CBD cause local variations in the vibrations at the ground surface.

Second, the soils are deformed by the seismic waves, both temporary displacements and permanent movements, and deformations (e.g., residual horizontal and vertical displacements, ground distortion, surface undulation, ground cracks and fissures). The soils are considered to have failed when ground deformation seriously affects the performance of land or structures.

In these ways, the composition of soils below the foundations can have a major influence on the behaviour of structures.

## 4.6 Soil liquefaction and lateral spreading

Soil can transform within seconds from its normal condition into a liquefied state as a result of strong ground shaking. Hydrostatic pressure on the liquefied material causes it to flow towards an area of lower pressure, which is generally upwards to the surface. The water flow brings fine particles such as sand and silt with it, and these eventually re-solidify and provide the ground with some stable structure.

The process of liquefaction and, in particular, the ejection of the excess water between the grains of sediment (pore water) results in a complete loss of shear strength, which in turn can result in heavy structures sinking into the ground and light structures floating to the surface. This often leads to localised collapse zones, sinkholes and vents.

New soils formed from sediment that has settled on top of the ground are relatively weak. Contrary to what some at first thought, Cubrinovski and McCahon<sup>1</sup> state that repeated liquefaction of these areas can occur in further ground shaking events. This has been confirmed by Professor Bray<sup>2</sup> in his report to the Royal Commission.

Many areas that liquefied in the 4 September 2010 earthquake have liquefied up to five times more in subsequent earthquakes. The extent and severity of liquefaction varied across the CBD (Figure 2),



Figure 2: Preliminary liquefaction map indicating areas within the CBD affected by liquefaction in the 22 February earthquake. Red = moderate to severe liquefaction; green = low to moderate liquefaction (source: Cubrinovski and McCahon, August 2011)

Lateral spreading is a particular form of land movement associated with liquefaction, which produces large lateral ground displacements that can range from tens of centimetres to several metres. It is potentially very damaging to buildings and infrastructure. It typically occurs in ground close to waterways or in backfills behind retaining walls. If the underlying soils liquefy, the soil mass tends to move down-slope. The preceding liquefaction results in the soil providing very little resistance to the ground movement. Even on a gentle slope (2–3°) the loss of strength of the soil, coupled with the cyclic motion of the earthquake, can cause a down-slope movement to occur.

The local resistance of a pile comes from friction and end-bearing. The friction forces resist the settlement of the pile. If sand and silt around the pile liquefy, the friction is lost; then, when liquefaction ceases, the sand and silt settle and drag down on the pile. Thus the direction of the friction force reverses, driving the pile down so that end-bearing increases.

In general, lateral spreading displacements within the CBD were up to 30cm, but at a few locations about 50–70cm. This was less than in the eastern suburbs, where displacements in the February 2011 earthquake were often up to two metres. Spreading displacements were sometimes seen up to 150 metres from the Avon River. Any building in those areas is likely to have been subjected to some sort of stretching of its foundations.

#### 4.7 Damage to structures

Damage to piles can occur near the interface of different soil layers beneath buildings that are subject to cyclic (back and forth) movement. The movement can cause damage near the top of the pile structure and at the point where soft, deformable soils meet stiff soil layers. As the ground stretches beneath the building, large deformations may be imposed on the foundations. Substantial total settlements, differential settlements and tilting of buildings are common consequences of soil liquefaction.



All the features and modes of ground deformation discussed above are present and very pronounced in the case of lateral spreading. As the ground spreads laterally in one direction, it displaces the foundation permanently in this direction, in addition to imposing the cyclic temporary loadings. The biased loads associated with lateral spreading are particularly dangerous because they test the ductility (flexibility) of structures and their capacity to sustain large deformation without failure or collapse.

## 4.8 Impact of Alpine Fault rupture

Cubrinovski and McCahon<sup>1</sup> noted that an earthquake of magnitude 8 from a rupture of the Alpine Fault could lead to a long period of shaking in the Christchurch CBD, largely because the Alpine Fault is 650km long. They estimate such a rupture could produce 20–22 major cycles of shaking, whereas a magnitude 6 earthquake might produce only five significant cycles. A long period of shaking provides more time for amplification in soils and contributes to the impact of the earthquake on structures.

In an Alpine Fault event, peak ground accelerations at Christchurch will be materially lower, estimated at around 0.06–0.17 times the acceleration due to gravity (g), than those experienced in the February earthquake, because of the distance they travel from the source (at its closest point the Alpine Fault is 125km from Christchurch). In comparison, for the magnitude 6.2 February earthquake the peak ground accelerations within the CBD were much higher: 0.4–0.8g.

The combination of distance and large magnitude of an Alpine Fault event would lead to a long period of shaking, which would cause soil movement to a greater depth, perhaps 15–20 metres, compared with the top 5–8 metres that moved back and forth as a body in the February earthquake. Excitement of soils at different depths has a flow-on effect on how structures respond.

Cubrinovski and McCahon<sup>1</sup> made calculations to determine the peak ground accelerations that a magnitude 8 Alpine Fault earthquake would need to produce in the CBD in order to trigger the same level of liquefaction as the February earthquake. They concluded that it would be induced by peak ground accelerations that were less than half as strong as in the February earthquake.

In conclusion, liquefaction is likely to occur in an Alpine Fault earthquake but it is unlikely to be as great as in the February 2011 earthquake. There may, however, be cases where the soils perform poorly and liquefaction is worse owing to the long period of shaking that is likely to occur with a rupture of the Alpine Fault.

## 4.9 Canterbury earthquakes: performance of foundations

Table 1 shows a range of foundation types that have been used in the Christchurch CBD (Cubrinovski and McCahon<sup>1</sup>).

Table 1: Typical foundation types used within the CBD

Foundation type	Building type	Foundation soils
Shallow foundations (isolated spread footings with tie beams)	<ul style="list-style-type: none"> <li>Multi-storey buildings</li> <li>Low-rise apartment buildings</li> </ul>	<ul style="list-style-type: none"> <li>Shallow alluvial gravel</li> <li>Shallow sands, silty sands</li> </ul>
Shallow foundations (raft foundations)	<ul style="list-style-type: none"> <li>Multi-storey buildings</li> <li>Low-rise apartment buildings with basement</li> </ul>	<ul style="list-style-type: none"> <li>Shallow alluvial gravel</li> <li>Shallow sands, silty sands</li> </ul>
Deep foundations (shallow piles)	<ul style="list-style-type: none"> <li>Low-rise apartment buildings</li> </ul>	<ul style="list-style-type: none"> <li>Medium dense sands (soft silts and peat at shallow depths)</li> </ul>
Deep foundations (deep piles)	<ul style="list-style-type: none"> <li>Multi-storey buildings</li> </ul>	<ul style="list-style-type: none"> <li>Medium dense to dense sands (areas of deep soft soils or liquefiable sands underlain by dense sands)</li> </ul>
Hybrid foundations (combined shallow and deep foundations or combined shallow and deep piles)	<ul style="list-style-type: none"> <li>Multi-storey buildings</li> </ul>	<ul style="list-style-type: none"> <li>Highly variable foundation soils including shallow gravels and deep silty or sandy soils beneath the footprint of the building</li> </ul>

Liquefaction and the loss of strength of surface soils has had adverse effects on the building foundations in the CBD, including differential settlements, lateral movement of foundations, tilting of buildings and some bearing failures. Several buildings experienced serious consequences from the ground movement. We make the following observations based on the Cubrinovski and McCahon<sup>1</sup> report and our own consideration of a representative sample of buildings discussed in Volume 2 of this Report:

4.9.1 Shallow foundations bearing into shallow, dense gravels in some parts of the CBD performed variably because these deposits themselves were so variable. Stiff raft foundations bearing onto these shallow gravels appear to have performed well (see the discussion of the Christchurch Central Police Station and the CCC civic offices).

4.9.2 Shallow foundations on sites where ground improvement was carried out before construction also performed variably. While bearing failures were prevented by the ground improvement, there were some excessive differential settlements and tilting. As a result, some buildings had to be demolished.

4.9.3 Buildings on deep pile foundations generally fared better where the piles penetrated to competent soils at sufficient depth and were not underlain by liquefaction. However, a significant number of piled buildings suffered differential settlement where the bearing layer was too thin or underlain with liquefiable layers, or where there was a loss of side-resistance with liquefaction so the load was transferred to a soft end-bearing mechanism.

4.9.4 Even in areas of severe liquefaction, pile-supported structures generally showed less differential and residual movement, provided that the piles reached competent soils at depth.

- 4.9.5 Multi-storey and high-rise buildings supported on shallow foundations sitting on shallow gravels showed variable performance. Thickness of gravel and underlying soil layers resulted in some differential settlements, tilting and permanent lateral displacements. These adverse effects were especially pronounced in transition zones where ground conditions changed substantially over a short distance.
- 4.9.6 Hybrid foundations (where part of the building was on deep piles and part on shallow foundations) performed poorly because of differential movements between the two systems (see the discussion of the Victoria Square apartments building).
- 4.9.7 Other significant foundation damage included the failure of ground floor and basement slabs in uplift under the very high pore-water pressures associated with soil liquefaction and ground shaking (see the discussion of the Westpac Tower building).
- 4.9.8 Within the CBD, zones of ground weakness (whether localised or continuous over several blocks) showed pronounced ground distortion and liquefaction that adversely affected a number of buildings. Buildings as little as 20 metres apart behaved differently according to the condition of the ground. This was seen, for example, in Armagh Street.
- 4.9.9 The effects of lateral spreading in the CBD were localised but quite damaging to buildings, causing sliding and stretching of the foundations and structures (see the discussion of the Town Hall).

In addition, the performance of building foundations in the CBD was adversely affected by the interactions of adjacent buildings with the underlying soils, which further deformed the soils and exacerbated damage to neighbouring buildings.

Although pile-supported structures typically suffered less damage, piles can lose support when supported in or above soils that liquefy.

## 4.10 Seismic design and construction of building foundations in CBDs of New Zealand cities

This part of the Report addresses geotechnical considerations relevant to the design and construction of new buildings in New Zealand CBDs. Although many of the issues raised are general, the discussion is of particular relevance to the rebuild of the Christchurch CBD. It is obviously important that new development there should be robust, and constructed with foundations designed to ensure resilience of the above-ground structure.

### 4.10.1 Site geotechnical model

A thorough and detailed geotechnical investigation of each building site leading to development of a full site model is a key requirement for good foundation performance. The objective of the investigation should be to gain a good understanding of the geological history of the site (including the various soil strata), the future behaviour of the site and any variability across the site. The extent of the investigations should be sufficient to give designers confidence in predicting satisfactory performance of the site and the building foundations.

An individual site cannot be considered in isolation, but only in context with surrounding sites and the geomorphology of the area. Context is especially important when considering the risk of soil liquefaction and damaging lateral ground movements during earthquakes and other geological events. The limitations of the sub-surface information and the uncertainties inherent with a model should also be recognised and alternative interpretations of the data considered.

Better access to sub-surface data from neighbouring sites would assist the understanding the site geology, stratigraphy and context. Relevant data is often limited: often there are no records of previous geotechnical investigations and foundations. This creates an unacceptable hindrance to better understanding of adjacent site conditions and evaluation of the safety of existing buildings in New Zealand.

Sub-surface investigations, especially borings, are expensive and there is always a tension between the desire of the geotechnical engineer to obtain sufficient data and the desire of the developer to minimise cost. In Christchurch, the extent of sub-surface exploration has been variable, and often less than accepted practice in other centres in New Zealand and

internationally. While it is difficult and dangerous to set exact norms, a geotechnical investigation (which can be up to two per cent of the whole construction cost) would seem a modest investment compared to the risk of unsatisfactory performance. Given the extent of unsatisfactory seismic performance of foundations in Christchurch, a greater expenditure on geotechnical site investigations in future is warranted.

We note that the substantial Tonkin and Taylor<sup>4</sup> report is to be made publicly available and should be very helpful when designing foundations for new buildings in the Christchurch CBD, though it will not obviate the need for site-specific investigations. We assume that as more investigative work is carried out in the context of new developments, the results of that work will also be made publicly available. In time, a more detailed database will be available to guide the designer. We consider that there will be a clear public benefit if that process is followed.

Dr McManus<sup>3</sup> recommended that greater use should be made of the cone penetrometer test (CPT) for sub-surface exploration. This provides a standardised and cost-effective continuous profiling of ground conditions. By comparison, the standard penetration test (SPT) is carried out at fixed intervals, usually of 1.5 metres or more. Where the alluvial environment is highly variable this interval is far too coarse to properly characterise the sub-surface soils. CPT testing should be carried out to the depth of refusal (i.e., the maximum depth to which the pile can be driven without damage), at close enough separations across the site to be able to characterise the variability of the various strata.

The depth of penetration of the CPT test is often limited because the penetrometer cannot penetrate cobbly gravels or other very dense layers at depth. It will almost always be necessary to continue the sub-surface exploration to a greater depth using drilling equipment with SPT tests at intervals. If a significant thickness of weak soil continues beneath the dense layer causing refusal, it is possible to continue with the CPT if a temporary casing is left in place through the gravel after drilling.

The necessary depth of the sub-surface exploration, by whatever means, requires careful judgement by the geotechnical engineer. Frequently explorations are terminated at too shallow a depth. The depth of exploration should extend through all soil strata considered able to affect the behaviour of the site and the building foundations, and then continue to a sufficient additional depth to ensure all potential

problem soils have been identified. Where deep pile foundations are being considered, the exploration should continue well into the bearing stratum and at least 10 diameters below the intended founding depth.

Detailed guidelines for evaluation of soil liquefaction are provided by the New Zealand Geotechnical Society (NZGS). These should now be updated to include new information and experience from Christchurch. The preferred exploratory tool for liquefaction assessments is the CPT, supplemented by laboratory testing of soil samples recovered from layers identified as being at risk.

The potential for softening of granular soils under strong seismic shaking needs to be considered. It appears that in the Canterbury earthquakes, high pore-water pressures affected many gravel deposits as well as causing the more obvious liquefaction in sand. This resulted in upward heave of some basements founded directly on gravel, and the short-term loss of shear strength may have contributed to poor pile performance on some sites.

## Recommendations

We recommend that:

3. A thorough and detailed geotechnical investigation of each building site, leading to development of a full site model, should be recognised as a key requirement for achieving good foundation performance.
4. There should be greater focus on geotechnical investigations to reduce the risk of unsatisfactory foundation performance. The Department of Building and Housing should lead the development of guidelines to ensure a more uniform standard for future investigations, and as an aid to engineers and owners.
5. Geotechnical site reports and foundation design details should be kept on each property file by the territorial authority and made available for neighbouring site assessments by geotechnical engineers.

6. The Christchurch City Council should develop and maintain a publicly available database of information about the sub-surface conditions in the Christchurch CBD, building on the information provided in the Tonkin and Taylor<sup>4</sup> report. Other territorial authorities should consider developing and maintaining similar databases of their own.
7. Greater use should be made of in situ testing of soil properties by the CPT, SPT or other appropriate methods.
8. The Department of Building and Housing should work with the New Zealand Geotechnical Society to update the existing guidelines for assessing liquefaction hazard to include new information and draw on experience from the Christchurch earthquakes.
9. Further research should be conducted into the performance of building foundations in the Christchurch CBD, including sub-surface investigations as necessary, to better inform future practice.

#### 4.10.2 Foundation loadings and design philosophy

The principal loads to be resisted by the foundations are determined by the structural engineer after analysing the proposed building specifications and using structural design actions and combinations of actions specified in NZS 1170.5<sup>5</sup>. This Standard covers most design actions including self-weight, live load, wind, snow, earthquake, static liquid pressure, groundwater, rainwater ponding and earth pressure. The resulting loads to be resisted by the foundations include vertical and horizontal components and sometimes moments.

Earthquake actions differ from other structural actions in several important respects:

- (a) Loading arises from ground accelerations that are impossible to predict in advance. Instead, design accelerations based on probabilistic analysis are used. The actual accelerations in any earthquake event will always be either greater or less than the design acceleration.
- (b) The ground accelerations must be transmitted into the building by the foundations. Compliance of the foundations may reduce the acceleration of the building but the resulting relative displacements may damage the foundations.
- (c) Earthquake shaking changes the strength and stiffness of the founding soils and reduces the capacity of the foundations. In an extreme situation some soils may liquefy (i.e., lose almost all of their strength and stiffness).
- (d) Ground deformation during earthquake shaking induces indirect loads in deep pile foundations, including both instantaneous and permanent (kinematic) loads as well as the building loads.

Two limit states for the building are required to be considered separately by the designers under NZS 1170.5<sup>5</sup>. These are the serviceability limit state (SLS), corresponding to specified service criteria for a building (often deformation limits), and the ultimate limit state (ULS), corresponding to specified strength and stability criteria together with a requirement for robustness (ability to withstand overload without sudden collapse). These concepts are addressed in section 3 of this Volume.

#### 4.10.3 Serviceability limit state (SLS)

The main requirement of the foundations at the SLS is to minimise deformations (especially settlements), to limit damage and enable uninterrupted use of the building.

Dr McManus<sup>3</sup> observed that in cases where liquefaction or significant softening is expected at the site during an SLS-level earthquake it will be very difficult to meet the settlement criteria unless the building is founded on well-engineered deep piles, or on shallow foundations where well-engineered ground improvement is carried out.

Load factors and strength-reduction factors are not applied under NZS 1170.5<sup>5</sup> when considering the SLS load case. Instead, given the uncertainty in estimating foundation settlements, designers should use conservative assumptions for soil parameters.

## Recommendations

We recommend that:

10. Where liquefaction or significant softening may occur at a site for the SLS earthquake, buildings should be founded on well-engineered, deep piles or on shallow foundations after well-engineered ground improvement is carried out.
11. Conservative assumptions should be made for soil parameters when assessing settlements for the SLS.



#### 4.10.4 Ultimate limit state

ULS actions and combinations are much less likely to occur during the lifetime of the building but need to be resisted with a very low risk of structural collapse or failure of parts relevant to life safety. The cost of damage repair after a ULS event may be substantial and repair may be uneconomic, resulting in demolition of the building.

The foundations form a key component of the overall building structure and their performance is critical to the safe and satisfactory performance of the building. Failure or excessive deformation of the foundations may threaten the stability of the building, prevent the intended lateral resistance mechanisms from developing, and cause excessive ductility demands on building elements, increasing the risk of collapse.

Buried foundation elements such as deep piles are difficult or even impossible to repair after an earthquake and preferably it should be the building superstructure that yields rather than the foundations. Excessive foundation deformations and tilting of buildings in Christchurch have required demolition of many buildings that were otherwise not badly damaged.

The foundations of a building should not fail or deform excessively before the building develops its full intended structural response, including member overstrengths. To ensure a sufficient level of reliability for the foundations under ULS loading, strength-reduction factors must be applied to the calculated capacities.

Deformation of the foundations under ULS loads (including overstrength actions) should also be considered. While there is no need to achieve the same low level of deformation as in the SLS case, the deformations must not be so great that they add appreciably to the ductility demand placed on the structure or prevent the intended structural response.

The deformations required to fully mobilise the calculated strength capacity of shallow foundations may be very large and are likely to govern design. Deep foundations may also suffer significant axial deformations, with soil liquefaction and other cyclic softening effects during earthquake shaking causing redistribution of loads along the pile length. Realistic assessments should be made of likely settlements, which should remain within acceptable limits.

The load path for transmitting horizontal ground accelerations into the building must be carefully considered. Yielding of the foundation soils may reduce

the accelerations transmitted into the building, but the resulting relative deformations may still damage foundation elements and need to be carefully considered.

The three main available load paths are:

- sliding friction between the supporting soils and the underside of the building;
- passive resistance of the soil against downstand beams and other vertical faces such as basement walls and lift pits; and
- lateral resistance of piles (where present).

The allocation of load among these three mechanisms will depend on the relative stiffness of each load path. Typically, sliding friction comes first, then passive resistance of vertical faces, then lateral resistance of deep piles.

Where no piles are present there is a complex interaction between sliding friction and passive resistance against downstand beams (McManus<sup>6</sup>). Where deep piles are supporting the weight of the building, friction is likely to vanish rapidly because of soil settlement and should be discounted.

Deep pile foundations are also subject to indirect loading from soil deformation during and after earthquake shaking (kinematic loading). Ground shaking results in shear deformation in the soil column and deep piles are stressed as they try to resist these deformations. The most damaging kinematic effects on piles are from lateral spreading of the stiff surface crust relative to the base of the piles, which are usually embedded in a strong, non-moving bearing layer.

## Recommendations

We recommend that:

12. Foundation deformations should be assessed for the ULS load cases and overstrength actions, not just foundation strength (capacity). Deformations should not add unduly to the ductility demand of the structure or prevent the intended structural response.
13. Guidelines for acceptable levels of foundation deformation for the ULS and overstrength load cases should be developed. The Department of Building and Housing should lead this process.

#### 4.10.5 Strength-reduction factors

Designing building foundations in New Zealand may be described as a load and resistance factor design (LRFD) procedure, in which the uncertainty and variability in the loads and design actions on foundation elements are considered separately from the uncertainty and variability in the resistance of the foundation elements.

The appropriate load factors are given in AS/NZS 1170<sup>7</sup>. For earthquake loads, the load factor is 1 because the uncertainty in earthquake loads is accounted for directly within the probabilistic analysis underlying the code.

Strength-reduction factors for foundations are given in the New Zealand Building Code (NZBC) Verification Method 4 (B1/VM4) and are typically quite low (down to 0.4) because of the low reliability of foundation capacity assessments. The reasons for this low reliability include the inherent variability of soil deposits, uncertainty in measuring soil properties, complex behaviour of soil materials and uncertainty in modelling foundation behaviour.

For earthquake load cases involving earthquake overstrength, B1/VM4 permits the use of a strength-reduction factor of 0.8–0.9, irrespective of the level of uncertainty in the assessment of foundation capacity (which may be very large). The use of such high factors (equivalent to a safety factor of 1.1–1.25) is inappropriate in most cases and implies a significant risk that individual foundation elements will be loaded beyond their capacity, resulting in excessive plastic deformations. The high variability in capacity among individual foundation elements means that the structure may not behave as the designer intended.

Strength-reduction factors for the gravity load resisting elements of the foundation should be based on a risk-based procedure such as AS 2159–2009<sup>8</sup>. The objective should be to ensure reliable foundation performance under all load combinations before, during and after an earthquake. B1/VM4 should be revised accordingly.

## Recommendations

We recommend that:

14. The concessional strength-reduction factors in B1/VM4 for load cases involving earthquake load combinations and overstrength actions ( $\Phi_g = 0.8\text{--}0.9$ ) should be reassessed.
15. The strength-reduction factors in B1/VM4 should be revised to reflect international best practice including considerations of risk and reliability.

The development of full ULS lateral load resistance of foundation elements is not always critical to the safe performance of buildings. Lateral loads are transmitted from the ground into the building, causing it to accelerate in sympathy with the moving ground. Premature yielding of shallow soils forming the lateral load path may have the beneficial effect of reducing that acceleration. The trade-off is relative lateral displacements between the foundation elements and the ground surface.

For buildings on shallow foundations, any relative lateral displacement (sliding) may contribute to bearing failure under footings, differential settlements and tilting. This should be avoided by applying appropriate strength-reduction factors in design.

For buildings on deep pile foundations, soil yielding may be beneficial, both in reducing building accelerations and in reducing pile kinematic effects. Pile axial capacity should not be affected.

## Recommendations

We recommend that:

16. For shallow foundations, soil yielding should be avoided under lateral loading by applying appropriate strength-reduction factors.
17. For deep pile foundations, soil yielding should be permitted under lateral loading, provided that piles have sufficient flexibility and ductility to accommodate the resulting displacements. In such cases, strength-reduction factors need not be applied.

### 4.10.6 Shallow foundation design

Many buildings in the Christchurch CBD were on shallow foundations, including a number of quite large and tall buildings. While their foundations performed well under gravity loading before the earthquakes, many performed poorly during the earthquakes, with large settlements and tilting, mainly where there was soil liquefaction and lateral spreading. However, most raft foundations supported by dense gravel strata at shallow depth (which occur intermittently in the CBD) performed well.

Overseas experience also indicates that strong, well-engineered, shallow foundations in dense, strong soil or robust improved ground can perform well during strong shaking.

For many smaller buildings the cost of deep foundations may be prohibitive but such foundations may be unnecessary if a sufficient thickness of strong soil underlies the site at a shallow depth. With poorer, weaker soils, it may be economic to apply well-engineered ground improvement so that shallow foundations can be used instead of deep pile foundations.

If a natural gravel raft is to be used to support a building, a realistic assessment needs to be made of the intended founding stratum to ensure that is sufficiently strong, thick and consistent across the site to provide reliable foundations. Allowance should be made for the effects of raised pore-water pressures penetrating the gravel raft from liquefaction of adjacent or underlying loose soils. For this reason, continuous concrete raft foundations should be preferred over isolated pad footings.

The following requirements for shallow foundations need to be carefully addressed by designers:

- (a) There must be a clearly identified bearing stratum at shallow depth that will provide adequate support for the building loads. Alternatively, well-engineered ground improvement must be carried out.
- (b) The near-surface bearing stratum must be thick and strong enough to bridge any underlying liquefiable or weak soils. The necessary thickness is relative to the weight of the building and building form, as well as the properties of the bearing stratum and underlying soils.
- (c) The bearing stratum must be proven to be continuous across the site in order to uniformly support the entire footprint of the building. No building should be supported partly on shallow foundations and partly on deep piles.
- (d) Where the bearing stratum overlies liquefiable soils, the foundation system should be well tied together and able to span any pockets where support may be lost as a result of pore-water penetration into the stratum. Multi-storey buildings should have raft foundations or deep pile foundations.
- (e) Where the bearing stratum overlies liquefiable soils the ground floor slab (or basement slab or raft) should be able to resist the very high pore-water pressures resulting from soil liquefaction at depth. Such high pressures have been found in Christchurch to penetrate even dense overlying gravels and cause heaving failure of floor slabs in contact with the ground surface.

Shallow foundations have the potential to function very well for buildings on sites with strong soils, natural gravel rafts overlying weaker soils, or where robust, well-engineered ground improvement is carried out. However, not all shallow foundations performed satisfactorily in Christchurch during the earthquakes. A range of complex issues needs to be addressed for satisfactory performance during strong earthquakes.

## Recommendation

We recommend that:

- 18. The Department of Building and Housing should lead the development of detailed guidelines to address the design and use of shallow foundations.

Settlement governs the design of shallow foundations for the SLS. Significant surface settlement is likely where liquefaction is liable to be triggered during an SLS-level earthquake in underlying soil strata. A conservative assessment should be made of the extent of differential settlements that may occur within the building, which should remain within the guidelines provided by NZS 1170.5. If any risk of tilting of multi-storey buildings is identified for the SLS (which is likely where lateral spreading occurs), then the building should be founded on deep piles.

Settlement also is likely to govern the design of shallow foundations for the ULS. Strength (capacity) calculations for shallow foundations are based on considerations of limiting equilibrium and require very large soil deformation to become fully mobilised.

Little guidance exists regarding acceptable foundation settlement for the ULS. Foundation deformations should not be so great as to increase the ductility demands on key elements of the structure, prevent the desired structural response during strong shaking, or otherwise increase the risk of collapse of the building.

Foundation settlements must not be so great as to add appreciably to the ductility demands placed on the structure or prevent the intended structural response.

Foundation (strength) capacity calculations should always be carried out (in addition to settlement calculations) for the ULS and appropriate strength-reduction factors applied. Allowance should be made for loss of soil strength during earthquake shaking (from increased pore-water pressure and other forms of cyclic softening), for inertial effects (so-called seismic bearing factors – e.g., Ghahramani and Berrill<sup>9</sup>), and friction acting along the base of the footing from lateral loading (inclined loading).

For shallow foundations, the two available load paths for transmitting inertial forces into the building are:

- sliding friction between the supporting soils and the underside of the building; and
- passive resistance of the soil against downstand beams and other vertical faces such as basement walls and lift pits.

Where no basement is present there is a complex interaction between sliding friction and passive resistance against downstand beams (McManus<sup>6</sup>). This may result in unexpected distribution of forces, differential settlements and tilting. Sliding of buildings on shallow foundations should be avoided.

## Recommendations

We recommend that:

19. The Department of Building and Housing should lead the development of more detailed guidance for designers regarding acceptable foundation deformations for the ultimate limit state (ULS).
20. Shallow foundations should be designed to resist the maximum design base shear of the building, so as to prevent sliding. Strength-reduction factors should be used.

### 4.10.7 Ground improvement

The objective of ground improvement is to treat loose, weak soils to prevent liquefaction and improve their strength and stiffness so shallow foundations may be safely used with satisfactory results. International experience has shown that buildings perform well where well-engineered, robust ground improvement has been carried out. The experience in Christchurch was more varied, despite the fact that the ground shaking was much more intense than the design ULS level. The performance of sites with ground improvement in Christchurch needs to be the subject of further detailed research to better understand the reasons for the variation in performance.

A very wide range of ground improvement techniques is available and these are subject to ongoing innovation. Techniques include in situ densification of loose and susceptible soils, improved drainage to reduce pore-water pressures during shaking, partial or total replacement of soils, in situ mixing of cementitious materials, and reinforcement to strengthen and stiffen soils. The many techniques and the parameters associated with each technique achieve a wide range of outcomes, both in terms of level of improvement and subsequent performance during shaking. The greater the improvement, the greater the cost, so there needs to be a degree of sophistication in specifying and monitoring these processes.

Many of the ground-improvement techniques are subject to proprietary technology and are heavily dependent on the knowledge, training and skills of the firms that developed the techniques and their site personnel carrying out the work. Many new techniques have been imported into New Zealand as a result of the Canterbury earthquakes and there are risks associated with the transfer of complex skills from well-established overseas operations to local operators. There are also risks associated with transfer of techniques developed overseas to the local geological situation. Track records established overseas may not be able to be immediately relied upon locally. On the other hand, the local presence of many top international firms provides a unique opportunity to inform and improve local practice and is a valuable resource for the rebuild of Christchurch.

Where ground improvement is being relied on to prevent soil liquefaction and to permit use of shallow foundations to support a building, the ground improvement effectively forms part of the foundation system of the building and should be considered

as such. The considerable uncertainty in predicting the performance of the ground after treatment should be taken into account during design by applying appropriate factors (similar to the strength-reduction factors used in pile and footing design) to ensure a reliable outcome.

The objective when designing ground-improvement works should be to provide a level of confidence and robust performance, not simply to achieve some narrowly specified soil parameter. There needs to be good case-study evidence of the performance of each technique during earthquakes, especially where they are to be used as part of the foundation system for a multi-storeyed building.

The performance of a building foundation, including any ground improvement, depends on the design. Quality assurance during installation and performance testing of the finished work should enhance the understanding of satisfactory foundation behaviour.

The design basis of many ground-improvement techniques is dispersed through the literature, with little uniformity of approach. There is a need to collate and distil this information to promote a more consistent and robust approach to design of ground improvement works.

## Recommendations

We recommend that:

21. The performance of ground improvement in Christchurch should be the subject of further research to better understand the reasons for observed variability in performance.
22. Ground improvement, where used, should be considered as part of the foundation system of a building and reliability factors included in the design procedures.
23. Ground-improvement techniques used as part of the foundation system for a multi-storey building should have a proven performance in earthquake case studies.
24. The Department of Building and Housing should consider the desirability of preparing national guidelines specifying design procedures for ground improvement, to provide more uniformity in approach and outcomes.

### 4.10.8 Deep foundation design

Deep piles can provide a good foundation for buildings at sites with poor foundation conditions near the ground surface, by transferring loads to deeper soil strata that are usually stronger, denser and older. They can also resist vertical uplift loads where required.

However, there are limitations and drawbacks with deep piles. They are vulnerable to relative lateral movements of the various soil strata during shaking (kinematic effects), loss of support and down-drag from liquefying intermediate soil strata, buckling within thick layers of liquefied soil, and damage from relative movements between the building and the ground surface. In loose, wet sands they can be difficult and expensive to install. Good performance is not assured without very careful engineering.

Not all deep foundations performed satisfactorily in Christchurch. The reasons for this have not yet been identified but probably include failure to penetrate into suitable bearing strata, loss of support caused by liquefaction and cyclic softening, and load redistribution along the piles caused by liquefaction and cyclic softening.

The following requirements for deep pile foundations need to be carefully addressed by designers:

- (a) There must be a clearly identified bearing stratum that will provide adequate support for the pile type and the building loads. Piles must be installed (driven, bored, screwed) to a target depth within the bearing stratum as determined by the site investigation and not simply driven to refusal or to a set.
- (b) The bearing stratum must be sufficiently deep to be below any layers of liquefiable or weak soils, or be thick enough to bridge over any underlying liquefiable or weak soils.
- (c) Caution is required where a bearing stratum is not continuous across the site. A conservative approach should be taken to ensure uniform support can be provided to the entire footprint of the building.
- (d) Piles must be capable of reliably transferring the vertical loads (including uplift loads) from the building to the bearing stratum, and meet settlement requirements (even with liquefaction and cyclic softening of overlying soils), including the effects of loss of side resistance, load redistribution and down-drag.



- (e) Piles must withstand relative lateral movements of intermediate soil strata (kinematic effects) including permanent lateral movement of the ground surface (lateral spread), without excessive damage that might compromise their ability to carry the building vertical loads reliably.
- (f) Piles must be able to transfer the horizontal ground accelerations into the building without excessive damage that might compromise their ability to carry the building vertical loads reliably.
- (g) Heavily loaded, slender piles penetrating through thick layers of liquefied soil may fail by buckling. The possibility of pile instability with liquefaction must be considered.

Deep foundations can provide very good foundations for buildings on difficult sites, but not all performed satisfactorily in the Canterbury earthquakes. A range of complex issues needs to be addressed for satisfactory performance during strong earthquakes.

## Recommendation

We recommend that:

- 25. Detailed guidelines for deep foundation design should be prepared to assist engineers and to provide more uniformity in practice. The Department of Building and Housing should lead this process.

Many types of deep foundations are available and they are the subject of continual innovation. Each type has different advantages and disadvantages that make it more or less suitable for earthquake-resistant design. The most suitable types commonly used in New Zealand are discussed below.

### 4.10.9 Driven piles

Driven piles (treated timber, precast concrete, steel tubes, steel H-piles) have a significant advantage over other pile types for seismic design because the driving process pre-loads the base of the pile in the targeted bearing-stratum while simultaneously mobilising negative side-resistance along the shaft in the overlying soils. This effect may significantly reduce pile settlement if liquefaction or cyclic softening occurs in the overlying soils.

Driven piles have become less popular in recent years because of issues with noise and vibration during

installation. Modern equipment and procedures help to minimise this and the temporary inconvenience during installation should be weighed against the significant performance advantages possible during earthquakes.

Where jetting, pre-drilling and vibrating hammers are used to help install piles through intermediate stiff strata and reduce noise and vibration, these procedures should not be used to penetrate into the targeted bearing stratum. The pile should be driven into the bearing stratum with a suitable hammer (gravity or hydraulic).

## Recommendation

We recommend that:

- 26. Because driven piles have significant advantages over other pile types for reducing settlements in earthquake-resistant design, building consent authorities should allow driven piles to be used in urban settings where practical.

### 4.10.10 Bored piles

Bored piles can have advantages over driven piles, including better penetration of difficult intermediate layers to reach any desired target depth, the ability to observe and confirm the properties of the bearing-stratum during construction, and the fact that they can be made to a large diameter. In some situations, large-diameter heavily reinforced bored piles may be able to resist lateral spreading.

### 4.10.11 Continuous flight auger (CFA) piles

CFA piles are bored piles installed using a hollow-stemmed auger that eliminates the need for ground support in caving conditions. They have most of the same advantages and disadvantages as bored piles but are more limited in diameter and depth range and have more limited penetration of difficult intermediate layers.

The main disadvantage of bored piles for sites where soil liquefaction occurs is that they are susceptible to loss of side-resistance with liquefaction and attendant down-drag from overlying non-liquefied layers. Bored piles obtain most of their initial axial load capacity from side-resistance, which is a much stiffer load-transfer mechanism than end-bearing, and when completed most of the building weight will be carried by side-resistance. With liquefaction, much of the side-resistance may be lost, resulting in a significant transfer of load to the base of the pile.

However, mobilisation of the end-bearing mechanism requires significant settlement to take place, typically 5–10 per cent of pile diameter. Greater settlement may occur where the base of the pile has been excessively disturbed during construction or poorly cleaned out.

Special construction techniques may be used either to pre-load the base of the pile or to reduce side-resistance through the upper liquefiable strata, but these all add cost. It is possible to pre-load the base of bored piles using pressure-grouting techniques or special devices. Excavating bored piles using bentonite slurry is known to reduce side-resistance and permanent sleeves may be installed. CFA piles pre-load the pile base to a limited extent by injecting concrete under pressure during installation.

Installation of deep bored piles in Christchurch (and in some other urban centres in New Zealand) may be complicated by the presence of artesian ground water pressures within the target gravel bearing strata.

#### 4.10.12 Screw piles

Screw piles consist typically of one or more steel plate helices welded to a steel tube. The pile is screwed into the ground and the tube filled with concrete. Torque measurements are used to identify penetration into the target-bearing stratum. These piles have the advantage for seismic loading that almost all the load is transferred to end-bearing on the steel helices embedded in the target bearing stratum, with minimal side-resistance along the shaft.

For all pile types, the risk of “punch through” into underlying layers of liquefiable soil needs to be considered. In the case of a very weak soil layer underlying a strong bearing layer, the weak layer may influence the bearing capacity of the pile for a thickness of least five diameters above the interface, and possibly more if high excess pore water pressures penetrate upwards into the bearing layer.

#### 4.10.13 Uplift capacity

Deep piles, especially bored piles, have often been used to resist large overturning actions generated by certain structural forms. Provided the site soils are not at risk of liquefaction or cyclic softening during earthquakes, the side-resistance mechanism will provide a stiff response in both compression and uplift. Cyclic degradation of the side-resistance mechanism may occur where the pile carries only light gravity loads, and should be considered.

Where liquefaction and/or cyclic softening of soils is likely to occur, deep piles may have limited capacity to resist uplift loads. Only the side-resistance from soil strata below the deepest liquefiable layer should be relied on to resist either uplift or compression during and after shaking.

In some locations (notably Wellington) belled piles have frequently been used to improve the uplift resistance of bored piles. The upper surface of the bell is considered to act as an upside-down footing and treated as such for the calculation of capacity. However, the mobilisation of end-bearing in soil, upwards or downwards, may require significant movement of the pile (5–10 per cent of diameter in each direction) and is likely to result in a very soft load-displacement response, especially if gapping develops. The resulting structural response may be more like foundation rocking, which can be quite different to that intended by the designer. Foundation movements, both upwards and downwards, are likely to govern design and need to be considered.

An upside-down punching shear failure is also possible where weak or liquefied soil overlies the founding stratum. Penetration of about five diameters into the founding stratum is necessary to develop maximum uplift capacity. The “punch through” failure mechanism should be considered for lesser embedment depths.

In overseas practice, belled piles are used infrequently because with modern drilling equipment it is preferable to use deeper-drilled, larger-diameter piles because side-resistance increases rapidly with depth. This should also provide a stiffer response under seismic loading.

Belled piles should only be used in firm, cohesive soils or weak rock in dry-hole conditions where the bell can be excavated without risk of collapse and carefully cleaned out and confirmed before concreting. Drilling belled piles in granular soils under fluid should not be permitted where the integrity of the bell cannot be assured.

Screw piles share many of the same issues as belled piles because they also rely on a bearing mechanism, both in compression and in uplift. The load-displacement response under compression/uplift cycling during an earthquake is likely to be very soft and govern design.

As for belled piles, the uplift capacity will be reduced by the presence of weak or liquefied overlying strata unless the helix is embedded at least five diameters into the bearing stratum. An “upside-down punch through” mechanism should be considered where embedment into the bearing stratum is less than five diameters.

#### 4.10.14 Kinematic effects

All deep pile foundations are vulnerable to kinematic effects where different soil strata undergo differential lateral movements during and after shaking. The most damaging effects arise where the non-liquefied surface crust undergoes significant permanent lateral deformation relative to the underlying bearing stratum. With significant soil liquefaction, permanent lateral movements of the surface crust are widespread and vary from extreme (severe lateral spreading near watercourses) to subtle but potentially damaging movements caused by minor surface gradients. In Christchurch, permanent lateral deformations of the ground surface, of up to 300mm, were widespread even in areas far from watercourses and without obvious surface manifestation of lateral-spreading damage. All deep pile foundations in areas where there is a risk of significant liquefaction should be designed to accommodate such movements, even when they are far from any watercourse.

Even where soil liquefaction is not considered an issue, kinematic effects can still arise through deformations of other weak soils, especially adjacent to steep slopes such as waterfronts and bridge abutments.

The main protection against kinematic effects for deep piles is flexibility and/or ductility. In most cases it will be impractical to make deep piles strong enough to prevent the kinematic movements because the mass of the moving soils is enormous and the non-liquefied soils will rapidly develop full passive pressure to act against the face of each pile. In most cases it will be acceptable for the piles and the supported building to move with the surface crust, provided the piles are sufficiently flexible and ductile to continue to safely carry the vertical loads from the building.

## Recommendation

We recommend that:

27. Where there is a risk of significant liquefaction, deep piles should be designed to accommodate an appropriate level of lateral movement of the surface crust even when they are far from any watercourse.

#### 4.10.15 Lateral loading

Where deep pile foundations are used, friction acting between the ground floor or basement slab should not be relied on to transmit base shear into the building, because of likely settlement of the ground surface relative to the building. Passive resistance of soil acting against vertical surfaces such as downstand beams and liftshafts may continue to provide a load path, provided ground settlement is not excessive. However, the passive resistance mechanism is often soft and in most cases it is likely that the main load path for lateral loads entering the building will be through the piles.

For some sites with weak or liquefied soils and insubstantial surface crust, it may not be possible to develop the calculated ULS design base shear for the building before the soil around the piles will yield. This may have the benefit of reducing the building accelerations and reducing the kinematic deformations of the piles and should be accepted. However, neither benefit should be counted on, either to reduce building element design forces or to reduce pile kinematic loads, because it is difficult to accurately predict the maximum passive resistance of the soil.

Care must be taken to ensure that a pile does not suffer a brittle structural failure that might compromise the axial capacity of the pile. The pile should be detailed with adequate ductility to withstand the maximum lateral load from building inertia when it is also being subjected to maximum kinematic deformation and carrying the necessary axial loads.

## Recommendations

---

We recommend that:

28. Base friction should not be included as a mechanism for lateral load transfer between the ground and the building when it is supported on deep piles.
29. If reliance is to be placed on passive resistance of downstand beams and other vertical building faces, a realistic appraisal of the relative stiffness of the load-displacement response of the passive resistance compared to the pile resistance should be made.
30. For buildings on deep piles, it is not essential that the calculated lateral capacity of the foundations should exceed the design base shear at the ULS, provided that the piles have sufficient flexibility and ductility to accommodate the resulting yield displacement and kinematic displacements.
31. There are major problems in the use of inclined piles where significant ground lateral movements may occur. Where the use of inclined piles is considered, the kinematic effects that may generate very large axial loads that could overload the pile and damage other parts of the structure connected to the pile should be considered.

### 4.10.16 Buckling and P-delta effects

Evidence from overseas indicates that heavily loaded, slender piles may buckle in thick layers of liquefied soil (Bhattacharya et al.<sup>10</sup>), although there are no known examples from Christchurch. P-delta effects have also been discussed as a possible problem for deep piles, but in most cases the pile head will be well restrained by the surface crust.

### 4.10.17 Cyclic effects

Even where soil liquefaction does not occur, cyclic axial loading of deep piles may cause degradation of the side-resistance mechanism, resulting in load transfer to the pile base and attendant settling and loss of uplift resistance. The most vulnerable piles are those carrying relatively light gravity loads or where cyclic load reversal (from compression to uplift) occurs.

## References

---

1. Cubrinovski, M. and McCahon, (August 2011). *Foundations on Deep Alluvial Soils*. Christchurch, New Zealand: Canterbury Earthquakes Royal Commission.
2. Letter from Jonathan D. Bray, J.D. Bray Consultants, LLC to Canterbury Earthquakes Royal Commission, 18 October 2011.
3. McManus, K.J. (2011). *Foundation Design Reliability Issues*. Christchurch, New Zealand: Canterbury Earthquakes Royal Commission.
4. Tonkin and Taylor Limited (2011). *Christchurch Central City Geological Interpretative Report*. Christchurch, New Zealand: Christchurch City Council.
5. NZS 1170.5:2004. *Structural Design Actions Part 5, Earthquake Actions*. Standards New Zealand.
6. McManus, K.J. (2003). Earthquake Resistant Foundation Design, *Proc. N.Z. Geotech. Soc. Symp., Tauranga, N.Z.*, (Invited theme paper).
7. AS/NZS 1170.0:2002. *Structural Design Actions, Part 0, General Principles*, Standards Australia/Standards New Zealand.
8. AS/NZS 2159:2009. *Piling – Design and Installation*. Standards Australia.
9. Ghahramani, A. and Berrill, J.B. (1995). Seismic Bearing Capacity Factors by Zero Extension Line Method, *Proc. Pacific Conference on Earthquake Engineering*, November 1995, 147-156.
10. Bhattacharya, S., Madabhushi, S.P.G. and Bolton, M.D. (2004). An alternative mechanism of pile failure in liquefiable deposits during earthquakes, *Geotechnique* 54, No. 3, 203-213.



# Appendix 1: Terms of Reference

---

Royal Commission of Inquiry into Building Failure caused by Canterbury Earthquakes

Elizabeth the Second, by the Grace of God Queen of New Zealand and her Other Realms and Territories,  
Head of the Commonwealth, Defender of the Faith:

To The Honourable MARK LESLIE SMITH COOPER, of Auckland, Judge of the High Court of New Zealand;  
Sir RONALD POWELL CARTER, KNZM, of Auckland, Engineer and Strategic Advisor; and  
RICHARD COLLINGWOOD FENWICK, of Christchurch, Associate Professor of Civil Engineering:

GREETING:

## Recitals

WHEREAS the Canterbury region, including Christchurch City, suffered an earthquake on 4 September 2010 and numerous aftershocks, for example—

- (a) the 26 December 2010 (or Boxing Day) aftershock; and
- (b) the 22 February 2011 aftershock:

WHEREAS approximately 180 people died of injuries suffered in the 22 February 2011 aftershock, with most of those deaths caused by injuries suffered wholly or partly because of the failure of certain buildings in the Christchurch City central business district (CBD), namely the following 2 buildings:

- (a) the Canterbury Television (or CTV) Building; and
- (b) the Pyne Gould Corporation (or PGC) Building:

WHEREAS other buildings in the Christchurch City CBD, or in suburban commercial or residential areas in the Canterbury region, failed in the Canterbury earthquakes, causing injury and death:

WHEREAS a number of buildings in the Christchurch City CBD have been identified as unsafe to enter following the 22 February 2011 aftershock, and accordingly have been identified with a red card to prevent persons from entering them:

WHEREAS the Department of Building and Housing has begun to investigate the causes of the failure of 4 buildings in the Christchurch City CBD (the 4 specified buildings), namely the 2 buildings specified above, and the following 2 other buildings:

- (a) the Forsyth Barr Building; and
- (b) the Hotel Grand Chancellor Building:

WHEREAS it is desirable to inquire into the building failures in the Christchurch City CBD, to establish—

- (a) why the 4 specified buildings failed severely; and
- (b) why the failure of those buildings caused such extensive injury and death; and
- (c) why certain buildings failed severely while others failed less severely or there was no readily perceptible failure:

WHEREAS the results of the inquiry should be available to inform decision-making on rebuilding and repair work in the Christchurch City CBD and other areas of the Canterbury region:

## Appointment and order of reference

KNOW YE that We, reposing trust and confidence in your integrity, knowledge, and ability, do, by this Our Commission, nominate, constitute, and appoint you, The Honourable MARK LESLIE SMITH COOPER, Sir RONALD POWELL CARTER, and RICHARD COLLINGWOOD FENWICK, to be a Commission to inquire into and report (making any interim or final recommendations that you think fit) upon (having regard, in the case of paragraphs (a) to (c), to the nature and severity of the Canterbury earthquakes)—

## Inquiry into sample of buildings and 4 specified buildings

- (a) in relation to a reasonably representative sample of buildings in the Christchurch City CBD, including the 4 specified buildings as well as buildings that did not fail or did not fail severely in the Canterbury earthquakes—
  - (i) why some buildings failed severely; and
  - (ii) why the failure of some buildings caused extensive injury and death; and
  - (iii) why buildings differed in the extent to which—
    - (A) they failed as a result of the Canterbury earthquakes; and
    - (B) their failure caused injury and death; and
  - (iv) the nature of the land associated with the buildings inquired into under this paragraph and how it was affected by the Canterbury earthquakes; and
  - (v) whether there were particular features of a building (or a pattern of features) that contributed to whether a building failed, including (but not limited to) factors such as—
    - (A) the age of the building; and
    - (B) the location of the building; and
    - (C) the design, construction, and maintenance of the building; and
    - (D) the design and availability of safety features such as escape routes; and
- (b) in relation to all of the buildings inquired into under paragraph (a), or a selection of them that you consider appropriate but including the 4 specified buildings,—
  - (i) whether those buildings (as originally designed and constructed and, if applicable, as altered and maintained) complied with earthquake-risk and other legal and best-practice requirements (if any) that were current—
    - (A) when those buildings were designed and constructed; and
    - (B) on or before 4 September 2010; and
  - (ii) whether, on or before 4 September 2010, those buildings had been identified as “earthquake-prone” or were the subject of required or voluntary measures (for example, alterations or strengthening) to make the buildings less susceptible to earthquake risk, and the compliance or standards they had achieved; and
- (c) in relation to the buildings inquired into under paragraph (b), the nature and effectiveness of any assessment of them, and of any remedial work carried out on them, after the 4 September 2010 earthquake, or after the 26 December 2010 (or Boxing Day) aftershock, but before the 22 February 2011 aftershock; and

## Inquiry into legal and best-practice requirements

- (d) the adequacy of the current legal and best-practice requirements for the design, construction, and maintenance of buildings in central business districts in New Zealand to address the known risk of earthquakes and, in particular—
  - (i) the extent to which the knowledge and measurement of seismic events have been used in setting legal and best-practice requirements for earthquake-risk management in respect of building design, construction, and maintenance; and
  - (ii) the legal requirements for buildings that are “earthquake-prone” under section 122 of the Building Act 2004 and associated regulations, including—

- (A) the buildings that are, and those that should be, treated by the law as “earthquake-prone”; and
- (B) the extent to which existing buildings are, and should be, required by law to meet requirements for the design, construction, and maintenance of new buildings; and
- (C) the enforcement of legal requirements; and
- (iii) the requirements for existing buildings that are not, as a matter of law, “earthquake-prone”, and do not meet current legal and best-practice requirements for the design, construction, and maintenance of new buildings, including whether, to what extent, and over what period they should be required to meet those requirements; and
- (iv) the roles of central government, local government, the building and construction industry, and other elements of the private sector in developing and enforcing legal and best-practice requirements; and
- (v) the legal and best-practice requirements for the assessment of, and for remedial work carried out on, buildings after any earthquake, having regard to lessons from the Canterbury earthquakes; and
- (vi) how the matters specified in subparagraphs (i) to (v) compare with any similar matters in other countries; and

### Other incidental matters arising

- (e) any other matters arising out of, or relating to, the foregoing that come to the Commission’s notice in the course of its inquiries and that it considers it should investigate:

### Matters upon or for which recommendations required

And, without limiting the order of reference set out above, We declare and direct that this Our Commission also requires you to make both interim and final recommendations upon or for—

- (a) any measures necessary or desirable to prevent or minimise the failure of buildings in New Zealand due to earthquakes likely to occur during the lifetime of those buildings; and
- (b) the cost of those measures; and
- (c) the adequacy of legal and best-practice requirements for building design, construction, and maintenance insofar as those requirements apply to managing risks of building failure caused by earthquakes:

### Exclusions from inquiry and scope of recommendations

But, We declare that you are not, under this Our Commission, to inquire into, determine, or report in an interim or final way upon the following matters (but paragraph (b) does not limit the generality of your order of reference, or of your required recommendations):

- (a) whether any questions of liability arise; and
- (b) matters for which the Minister for Canterbury Earthquake Recovery, the Canterbury Earthquake Recovery Authority, or both are responsible, such as design, planning, or options for rebuilding in the Christchurch City CBD; and
- (c) the role and response of any person acting under the Civil Defence Emergency Management Act 2002, or providing any emergency or recovery services or other response, after the 22 February 2011 aftershock:

### Definitions

And, We declare that, in this Our Commission, unless the context otherwise requires,—

#### best-practice requirements

includes any New Zealand, overseas country’s, or international standards that are not legal requirements

#### Canterbury earthquakes

means any earthquakes or aftershocks in the Canterbury region—

- (a) on or after 4 September 2010; and
- (b) before or on 22 February 2011

### Christchurch City CBD

means the area bounded by the following:

- (a) the 4 avenues (Bealey Avenue, Fitzgerald Avenue, Moorhouse Avenue, and Deans Avenue); and
- (b) Harper Avenue

### failure

in relation to a building, includes the following, regardless of their nature or level of severity:

- (a) the collapse of the building; and
- (b) damage to the building; and
- (c) other failure of the building

### legal requirements

includes requirements of an enactment (for example, the building code):

## Appointment of chairperson

And We appoint you, The Honourable MARK LESLIE SMITH COOPER, to be the chairperson of the Commission:

## Power to adjourn

And for better enabling you to carry this Our Commission into effect, you are authorised and empowered, subject to the provisions of this Our Commission, to make and conduct any inquiry or investigation under this Our Commission in the manner and at any time and place that you think expedient, with power to adjourn from time to time and from place to place as you think fit, and so that this Our Commission will continue in force and that inquiry may at any time and place be resumed although not regularly adjourned from time to time or from place to place:

## Information and views, relevant expertise, and research

And you are directed, in carrying this Our Commission into effect, to consider whether to do, and to do if you think fit, the following:

- (a) adopt procedures that facilitate the provision of information or views related to any of the matters referred to in the order of reference above; and
- (b) use relevant expertise, including consultancy services and secretarial services; and
- (c) conduct, where appropriate, your own research; and
- (d) determine the sequence of your inquiry, having regard to the availability of the outcome of the investigation by the Department of Building and Housing and other essential information, and the need to produce an interim report:

## General provisions

And, without limiting any of your other powers to hear proceedings in private or to exclude any person from any of your proceedings, you are empowered to exclude any person from any hearing, including a hearing at which evidence is being taken, if you think it proper to do so:

And you are strictly charged and directed that you may not at any time publish or otherwise disclose, except to His Excellency the Governor-General of New Zealand in pursuance of this Our Commission or by His Excellency's direction, the contents or purport of any interim or final report so made or to be made by you:

And it is declared that the powers conferred by this Our Commission are exercisable despite the absence at any time of any 1 member appointed by this Our Commission, so long as the Chairperson, or a member deputed by the Chairperson to act in the place of the Chairperson, and at least 1 other member, are present and concur in the exercise of the powers:

## Interim and final reporting dates

And, using all due diligence, you are required to report to His Excellency the Governor-General of New Zealand in writing under your hands as follows:

- (a) not later than 11 October 2011, an interim report, with interim recommendations that inform early decision-making on rebuilding and repair work that forms part of the recovery from the Canterbury earthquakes; and
- (b) not later than 11 April 2012, a final report:

And, lastly, it is declared that these presents are issued under the authority of the Letters Patent of Her Majesty Queen Elizabeth the Second constituting the office of Governor-General of New Zealand, dated 28 October 1983\*, and under the authority of and subject to the provisions of the Commissions of Inquiry Act 1908, and with the advice and consent of the Executive Council of New Zealand.

In witness whereof We have caused this Our Commission to be issued and the Seal of New Zealand to be hereunto affixed at Wellington this 11th day of April 2011.

Witness Our Trusty and Well-beloved The Right Honourable Sir Anand Satyanand, Chancellor and Principal Knight Grand Companion of Our New Zealand Order of Merit, Principal Companion of Our Service Order, Governor-General and Commander-in-Chief in and over Our Realm of New Zealand.

ANAND SATYANAND, Governor-General.

By His Excellency's Command—

JOHN KEY, Prime Minister.

Approved in Council—

REBECCA KITTERIDGE, Clerk of the Executive Council.

\*SR 1983/225

## Modifications to Reporting Requirements and Powers of Royal Commission of Inquiry into Building Failure Caused by Canterbury Earthquakes

Elizabeth the Second, by the Grace of God Queen of New Zealand and her Other Realms and Territories, Head of the Commonwealth, Defender of the Faith:

To The Honourable MARK LESLIE SMITH COOPER, of Auckland, Judge of the High Court of New Zealand; Sir RONALD POWELL CARTER, KNZM, of Auckland, Engineer and Strategic Adviser; and RICHARD COLLINGWOOD FENWICK, of Christchurch, Associate Professor of Civil Engineering:

GREETING:

WHEREAS by Our Warrant, dated 11 April 2011, issued under the authority of the Letters Patent of Her Majesty Queen Elizabeth the Second constituting the office of Governor-General of New Zealand, dated 28 October 1983, and under the authority of and subject to the provisions of the Commissions of Inquiry Act 1908, and with the advice and consent of the Executive Council of New Zealand, we nominated, constituted, and appointed you, the said The Honourable MARK LESLIE SMITH COOPER, Sir RONALD POWELL CARTER, KNZM, and RICHARD COLLINGWOOD FENWICK, to be a Commission to inquire into and report (making any interim or final recommendations that you think fit) upon certain matters relating to building failure caused by the Canterbury earthquakes:

AND WHEREAS by Our said Warrant you are required to report finally to His Excellency the Governor-General of New Zealand not later than 11 April 2012:

AND WHEREAS it is expedient that the time and other requirements for reporting under Our said Warrant should be modified as hereinafter provided:



NOW, THEREFORE, We do by these presents require you to report and make final recommendations (required and otherwise) on the matters in Our said Warrant as follows:

(a) not later than 29 June 2012, on matters that would inform early decision-making on rebuilding and repair work that forms part of the recovery from the Canterbury earthquakes;

and

(b) at any time before 12 November 2012 on any other matter, if you are able to do so; and

(c) not later than 12 November 2012, on all matters on which you have not otherwise reported:

AND WHEREAS it is expedient that the powers conferred by Our said Warrant be modified, We do by these presents declare that the powers are exercisable by the Chairperson, or a member deputed by the Chairperson to act in the place of the Chairperson, despite the absence of 1 or 2 of the persons appointed to be members of the Commission, so long as at least 1 other member concurs in the exercise of the powers:

AND it is declared that nothing in these presents affects any act or thing done or decision made by the Commission or any of its members, in the exercise of its powers, before the making of these presents:

And We do hereby confirm Our Warrant dated 11 April 2011 and the Commission constituted by that Warrant, except as modified by these presents:

And, lastly, it is declared that these presents are issued under the authority of the Letters Patent of Her Majesty Queen Elizabeth the Second constituting the office of Governor-General of New Zealand, dated 28 October 1983, and under the authority of and subject to the provisions of the Commissions of Inquiry Act 1908, and with the advice and consent of the Executive Council of New Zealand.

In Witness whereof We have caused these presents to be issued and the Seal of New Zealand to be hereunto affixed at Wellington this 7th day of February 2012.

Witness Our Trusty and Well-beloved Lieutenant General The Right Honourable Sir Jerry Mateparae, Chancellor and Principal Knight Grand Companion of Our New Zealand Order of Merit, Principal Companion of Our Service Order, Governor-General and Commander-in-Chief in and over Our Realm of New Zealand.

[L.S.]

LT GEN SIR JERRY MATEPARAE, Governor-General

By His Excellency's Command-

JOHN KEY, Prime Minister.

Approved in Council-

REBECCA KITTERIDGE, Clerk of the Executive Council.

---

# Appendix 2: Expert advisers

---

## Expert advisers

John Berrill, Director, Canterbury Seismic Instruments

Brendon Bradley, Lecturer, Department of Civil and Natural Resources Engineering, University of Canterbury

David Brunson, Kestral Group, Wellington

Andrew Buchanan, Professor of Timber Design, Department of Civil and Natural Resources Engineering, University of Canterbury

Desmond Bull, Holcim Adjunct Professor in Concrete Design, Department of Civil and Natural Resources Engineering, University of Canterbury

Athol Carr, Professor Emeritus, Department of Civil and Natural Resources Engineering, University of Canterbury

Charles Clifton, Associate Professor of Civil Engineering, Department of Civil and Environmental Engineering, The University of Auckland

CompuSoft Engineering Ltd, Civil, Structural and Mechanical Engineers, Auckland

Misko Cubrinovski, Associate Professor Emeritus, Department of Civil and Natural Resources Engineering, University of Canterbury

Rajesh Dhakal, Associate Professor, Department of Civil and Natural Resources Engineering, University of Canterbury

GNS Science, Wellington

Michael Griffith, Professor, Department of Civil, Environmental and Mining Engineering, University of Adelaide

John Hare, Executive Director, Holmes Consulting Ltd and President, Structural Engineering Society of New Zealand (SESOC)

Jason Ingham, Associate Professor, Department of Civil and Environmental Engineering, The University of Auckland  
Institution of Professional Engineers New Zealand (IPENZ)

Ian McCahon, Principal, Geotech Consulting Ltd, Christchurch

Kevin McManus, Geotechnical Engineer, Nelson

Les Megget, Retired Senior Lecturer, Department of Civil and Environmental Engineering, The University of Auckland

Gregory MacRae, Associate Professor, Department of Civil and Natural Resources Engineering, University of Canterbury  
New Zealand Society for Earthquake Engineering Inc (NZSEE)

Alessandro Palermo, Senior Lecturer, Department of Civil and Natural Resources Engineering, University of Canterbury

Stefano Pampanin, Associate Professor, Department of Civil and Natural Resources Engineering, University of Canterbury

Michael Pender, Professor, Department of Civil and Environmental Engineering, The University of Auckland

Jarg Pettinga, Professor, Department of Geological Sciences, University of Canterbury

Spencer Holmes Ltd, Civil and Structural Engineers, Wellington

Structural Engineering Society of New Zealand (SESOC)

Tonkin and Taylor Ltd, Environmental and Engineering Consultants, Christchurch

### **International peer reviewers/experts**

Norman Abrahamson, Adjunct Professor, Department of Civil and Environmental Engineering, University of California at Berkeley

Ralph Archuleta, Professor, Department of Earth Science, University of California at Santa Barbara

Jonathan Bray, Professor, Department of Civil and Environmental Engineering, University of California at Berkeley

William Holmes, Principal, Rutherford and Chekene, Consulting Engineers, San Francisco

Bret Lizundia, Principal, Rutherford and Chekene, Consulting Engineers, San Francisco

Fred Turner, Staff Structural Engineer, Alfred E. Alquist, Seismic Safety Commission, California

# Appendix 3:

## Submitters and witnesses

Submissions received: Seismicity	
Person or organisation	Paper/book
Auckland Council	<i>Submission to the Canterbury Earthquakes Royal Commission by the Civil Defence Emergency Management Group/Auckland Council.</i>
Department of Building and Housing	<i>Department of Building and Housing submission on the GNS Science report “Canterbury Earthquakes sequence and implications for Seismic design levels.”</i>
The Royal Society of New Zealand	<i>The Darfield Earthquake: The value of long-term research.</i>
	<i>The Canterbury Earthquakes: Scientific answers to critical questions (co-authored with the Office of the Prime Minister’s Science Advisory Committee.)</i>
	<i>The Canterbury Earthquakes: Answers to critical questions about buildings.</i>
Rachael Ford and Ed Radley	<i>Submission to the Royal Commission: Seismic Hearing 2011.</i>
Dr David Hopkins	<i>The Canterbury Earthquakes: Implications for Building and Construction Standards.</i>
Ken Sibly	<i>Christchurch – Past, Present and Future.</i> Enclosures:
	Clark, W. (1878). <i>Drainage Scheme for Christchurch and the Suburbs: With Plan, and Explanatory Diagrams.</i> Christchurch, New Zealand: Author.
	Wilson, J. (1999). <i>Christchurch: Swamp to City: A Short History of the Christchurch Drainage Board, 1875-1989.</i> Lincoln, New Zealand: Te Waihora Press.
James Quinwallace	<i>A Scientific Understanding of the Canterbury Crustal Earthquakes: From 4 September 2010 to their Closure on 21 June 2011 and Addendum “Hysteresis Loop in Port Hills Seismic Shockwave”.</i>
	Quinwallace, J. (2011). <i>Love from Rolleston: The End of the Christchurch Quakes.</i> Christchurch, New Zealand: Jaquin Press.
Ross Thomson	Submissions by email on 1 September 2011 and 14 September 2011.

### Submissions received: Soil and ground conditions

Person or organisation	Paper
Christchurch City Council	<i>Submission on "Foundations on Deep Alluvial Soil" Report.</i>
Tonkin and Taylor	<i>Submission: Foundations on Deep Alluvial Soils.</i>
Malcolm Flain	<i>Submission.</i>
Dr David Hopkins	<i>The Canterbury Earthquakes: Implications for Building and Construction Standards.</i>
Dr Kevin McManus	<i>Foundation design reliability issues.</i>
Carl O'Grady	Submission by email on 16 September 2011.
Ken Sibly	<p><i>Christchurch – Past, Present and Future.</i> Enclosures:</p> <p>Clark, W. (1878). <i>Drainage Scheme for Christchurch and the Suburbs: With Plan, and Explanatory Diagrams.</i> Christchurch, New Zealand: Author.</p> <p>Map. <i>Christchurch Areas Showing Waterways, Swamp &amp; Vegetation Cover in 1856: Map compiled from 'Black Maps' approved by J Thomas &amp; Thomas Cass Chief Surveyors 1856.</i></p> <p>Wilson, J. (1999). <i>Christchurch: Swamp to City: A Short History of the Christchurch Drainage Board, 1875-1989.</i> Lincoln, New Zealand: Te Waihora Press.</p>
Ross Thomson	Submission by email on 20 September 2011.
David Penney	Submission by letter received on 1 November 2011 and by email on 23 October 2011 and 15 December 2011.

### Submissions received: PGC building

Person or organisation	Paper
Ken Sibly	<i>Submission on the PGC Building formally [sic] the Christchurch Drainage Board at 233 Cambridge Terrace.</i>

### Submissions received: Forsyth Barr and Hotel Grand Chancellor

Person or organisation	Paper
Heather Murdoch	Submission by email on 14 November 2011.



Submissions received: New building technologies (low-damage technologies)	
Person or organisation	Paper
Cement and Concrete Association of New Zealand	<i>Submission to the Royal Commission of Inquiry into Building Failure Caused by the Canterbury Earthquakes.</i>
Department of Building and Housing	<i>Department of Building and Housing submission to the Royal Commission for the Canterbury Earthquakes on New Building Technologies.</i>
Heavy Engineering Research Association	<i>HERA Submission to the October 2011 Interim Report.</i>
Precast New Zealand Incorporated	<i>A Submission to the Canterbury Earthquakes Royal Commission.</i>
The Royal Society of New Zealand	<i>The Canterbury Earthquakes: Scientific answers to critical questions (co-authored with the Office of the Prime Minister's Science Advisory Committee, Resubmitted.</i>
Steel Construction New Zealand Incorporated	<i>Submission by Steel Construction New Zealand Incorporated to Canterbury Earthquakes Royal Commission.</i>
Colin Ashby	<i>Further Submission to the Canterbury Earthquakes Royal Commission on Base Isolation.</i>
Charles Clifton Associate Professor of Civil Engineering, The University of Auckland	<i>Christchurch Earthquake Series: The Case for Structural Steel Systems. Presentation to the Royal Commission.</i>  <i>Submission by letter received on 19 October 2011.</i>
Rajesh Dhakal Associate Professor, Department of Civil and Natural Resources Engineering, University of Canterbury	<i>Submission by email received on 26 March 2012.</i>
Trevor Kelly Technical Director, Holmes Consulting Group	<i>Submission by email received on 19 March 2012.</i>

**Submissions received: Structural Engineering Society New Zealand Practice Note: *Design of Conventional Structural Systems Following the Canterbury Earthquakes***

*(Submitted to the Canterbury Earthquakes Royal Commission)*

Person or organisation	Paper
Aurecon	<i>Submission to the Royal Commission Inquiry into the Canterbury Earthquake [sic].</i>
Beca Carter Hollings and Ferner Limited	<i>Submission concerning SESOC Practice Note “Design of Conventional Structural Systems following the Canterbury Earthquakes.”</i>
Construction Techniques Group Limited	<i>Concerning: Design of Conventional Structural Systems Following The Canterbury Earthquakes.</i>
Compusoft Engineering	<i>Submission regarding SESOC Practice Note: Design of Conventional Structural Systems Following the Canterbury Earthquakes.</i>
Department of Building and Housing	<i>Department of Building and Housing Submission on the Structural Engineering Society of New Zealand (SESOC) Practice Note on the Design of Conventional Structural Systems following the Canterbury Earthquakes.</i>
Dunning Thornton Consultants	<i>Comments on SESOC Practice Note: Design of Conventional Structural Systems Following the Canterbury Earthquakes.</i>
Hamilton City Council	<i>Submission by email on 15 February 2012.</i>
Standards Council	<i>Royal Commission of Inquiry into Building Failure Caused by the Canterbury Earthquakes: Standards Council – Submission 2.</i>
Structural Engineering Society New Zealand Incorporated	<i>SESOC Practice Note. Design of Conventional Structural Systems Following the Canterbury Earthquakes.</i>
Colin Ashby	<i>Submission to the Canterbury Earthquake Royal Commission On the Paper “Design of Conventional Structural Systems Following The Canterbury Earthquakes.”</i>
Dene Cook Chairman of the NZS 3101 Committee	<i>SESOC Practice Note – Design of Conventional Structural Systems following the Canterbury Earthquake.</i>
Michael Pender Professor of Geotechnical Engineering, University of Auckland	<i>Submission to the Canterbury Earthquakes Royal Commission re SESOC documents to the Royal Commission of September and December 2011 – Comments from Michael Pender.</i>

Witnesses who appeared at the hearing for seismicity (17–20 October 2011)		
Person	Organisation	Hearing
Norman Abrahamson	Adjunct Professor, Department of Civil and Environmental Engineering, University of California at Berkeley (video)	19 October 2011
Dr Kelvin Berryman	Manager, Natural Hazards Research Platform, GNS Science	19 October 2011
Rachael Ford	Interested party (video)	18 October 2011
Dr Graeme McVerry	Principal Scientist, Hazards Group, GNS Science	18 October 2011, 19 October 2011
Jarg Pettinga	Professor, Department of Geological Sciences, University of Canterbury	18 October 2011, 19 October 2011
Dr Terry Webb	Director, Natural Hazards Division, GNS Science	17 October 2011, 18 October 2011, 19 October 2011

Witnesses who appeared at the hearing for soil and ground conditions (25 October 2011)		
Person	Organisation	Hearing
Jonathan Bray	Professor, Department of Civil and Environmental Engineering, University of California at Berkeley (video)	25 October 2011
Ian McCahon	Principal, Geotech Consulting Limited	25 October 2011
Misko Cubrinovski	Associate Professor, Department of Civil and Natural Resources Engineering, University of Canterbury	25 October 2011
Kevin McManus	Interested party	25 October 2011

Witnesses who appeared at the hearing for the PGC building (28 November – 6 December 2011)		
Person	Role/Organisation	Hearing
Alistair Boys	Structural engineer, Holmes Consulting Group	30 November 2011
Howard Buchanan	Commercial Manager, NAI Harcourts	29 November 2011
Stephen Collins	Director, Cambridge 233 Ltd (building owner)	28 November 2011
Helen Golding	Tenant	29 November 2011
Helen Guiney	Perpetual (tenant)	28 November 2011
Colin Hair	Company Secretary, Pyne Gould Corporation (former owner and tenant)	29 November 2011
John Hare	Director, Holmes Consulting Group	5 December 2011
William Holmes	Rutherford & Chekene, Consulting Engineers (peer reviewed the Department of Building and Housing's technical investigation reports for the Royal Commission)	6 December 2011
Rob Jury	Manager of Wellington Structural, Beca	5 December 2011
Stephen McCarthy	Environmental Policy and Approvals Manager, Christchurch City Council	28 November 2011, 29 November 2011
Ann-Cherie Manawatu-Pearcy	Senior Property Manager, NAI Harcourts	30 November 2011
Nigel Priestley	Emeritus Professor, University of California at San Diego and Emeritus Co-director of the ROSE School	5 December 2011, 6 December 2011
Glenys Ryan	Education Review Office (tenant)	28 November 2011
David Sandeman	Marsh Insurance (tenant)	28 November 2011
Dr Richard Sharpe	Technical Director of Earthquake Engineering, Wellington, Beca	5 December 2011
Julia Stannius	MARAC (tenant)	28 November 2011
Louise Sutherland	Commercial Property Manager, NAI Harcourts	29 November 2011
James West	Operations and Financial Controller, Pyne Gould Corporation	29 November 2011
Mark Whiteside	Structural engineer, Holmes Consulting Group	30 November 2011
Robert Wynn	Witness to the collapse of the PGC building	28 November 2011

Witnesses who appeared at the hearing for the Hotel Grand Chancellor (17–18 January 2010; 15 March 2012)		
Person	Organisation	Hearing
John Hare	Director, Holmes Consulting Group	18 January 2012
Gary Haverland	Director, Structex Metro, Structex	18 January 2012
William Holmes	Principal, Rutherford & Chekene, Consulting Engineers, San Francisco (engaged by the Royal Commission to peer review the Department of Building and Housing reports)	18 January 2012
Andrew Lind	Structural Engineer, Powell Fenwick	18 January 2012
Steve Martin	General Manager, Hotel Grand Chancellor (video)	18 January 2012
Stephen McCarthy	Environmental Policy and Approvals Manager, Christchurch City Council	18 January 2012
Stefano Pampanin	Associate Professor, Department of Civil and Natural Resources Engineering, University of Canterbury (member of the Expert Panel appointed by the Department of Building and Housing)	17 January 2012
Adam Thornton	Managing Director, Dunning Thornton Consultants (author of the report on the Hotel Grand Chancellor prepared for the Department of Building and Housing)	17 January 2012

Witnesses who appeared at the hearing for the Forsyth Barr building (23–24 February 2012)		
Person	Organisation	Hearing
Desmond Bull	Holcim Adjunct Professor in Concrete Design, Department of Civil and Natural Resources Engineering, University of Canterbury	24 February 2012
Grant Cameron	GCA Lawyers (tenant of the Forsyth Barr building)	23 February 2012
Ewan Carr	Tenant of the Forsyth Barr building	23 February 2012
John Hare	Director, Holmes Consulting Group	24 February 2012
Rob Jury	Manager of Wellington Structural, Beca (author of the Department of Building and Housing's technical investigation report into the Forsyth Barr stairs)	23 February 2012
Stephen McCarthy	Environmental Policy and Approvals Manager, Christchurch City Council	23 February 2012
Nigel Priestley	Emeritus Professor, University of California at San Diego and Emeritus Co-director of the ROSE School (member of the Department of Building and Housing's Expert Panel)	23 February 2012
Dr Richard Sharpe	Technical Director of Earthquake Engineering, Wellington, Beca (author of the Department of Building and Housing's technical investigation report into the Forsyth Barr stairs)	23 February 2012
Paul Tonkin	Site manager for the construction of the Forsyth Barr building (formerly employed by Fletcher Construction)	24 February 2012

Witnesses who appeared at the hearing for new building technologies (12–14 March 2012)		
Person	Organisation	Hearing
Mark Batchelar	Principal, MLB Consulting Engineers	13 March 2012
Andrew Buchanan	Professor of Timber Design, Department of Civil and Natural Resources Engineering, University of Canterbury	13 March 2012
Desmond Bull	Holcim Adjunct Professor in Concrete Design, Department of Civil and Natural Resources Engineering, University of Canterbury	13 March 2012
Andrew Charleson	Associate Professor, School of Architecture, Victoria University	14 March 2012
Charles Clifton	Associate Professor of Civil Engineering, Department of Civil and Environmental Engineering, The University of Auckland	13 March 2012
Carl Devereux	Technical Director, Aurecon Group	13 March 2012
Megan Devine	General Manager, Robinson Seismic	12 March 2012
Rajesh Dhakal	Associate Professor, Department of Civil and Natural Resources Engineering, University of Canterbury	12 March 2012
Sean Gledhill	Technical Director, Aurecon Group	13 March 2012
John Hare	Director, Holmes Consulting Group	13 March 2012
Gary Haverland	Director, Structex Metro, Structex	13 March 2012
David Kelly	Deputy Chief Executive, Building Quality, Department of Building and Housing	14 March 2012
Trevor Kelly	Technical Director, Holmes Consulting Group	12 March 2012
Stefano Pampanin	Associate Professor, Department of Civil and Natural Resources Engineering, University of Canterbury	13 March 2012
Didier Pettinga	Project Engineer, Holmes Consulting Group	12 March 2012
Nigel Priestley	Emeritus Professor, University of California at San Diego and Emeritus Co-director of the ROSE School	12 March 2012
Pierre Quenneville	Professor, Professor of Timber Design and Head of Department, Department of Civil and Environmental Engineering, The University of Auckland	14 March 2012
John Reelick	Tuakau Timber Treatment	13 March 2012
Dr Richard Sharpe	Technical Director of Earthquake Engineering, Wellington, Beca	12 March 2012
Peter Thorby	Manager, Building Standards Group, Department of Building and Housing	14 March 2012
Trevor Watt	New Zealand Institute of Architects	14 March 2012
Grant Wilkinson	Senior design engineer, Ruamoko Solutions	12 March 2012



# Appendix 4:

## Glossary of terms

Active link	A ductile shear yielding element in an eccentrically braced steel frame.
Base isolation	A means of limiting the seismic forces induced in a building by supporting the structure on devices that enable relative movement to occur between the foundation and superstructure when the force rises to a predetermined level.
Base shear	Base shear is the shear force acting between the foundation soils and the building due to the inertial force induced in the structure due to the ground motion.
Bending moment	See section 3: Introduction to Seismic Design of Buildings, Volume 1 of this Report.
Bond stress	The shear stress between reinforcement and concrete.
Building classification	Buildings are classified in terms of importance levels 1 to 5 in AS/NZS 1170.0. Level 1 is for the lowest, and applies, for example, to isolated farm buildings. Level 2 covers most multi-storey structures, while level 3 is for buildings that may contain a large number of people such as hotels, offices and apartment buildings over 15 storeys in height. Level 4 is assigned to buildings required to cater for medical emergencies and to be operational immediately following a major earthquake and level 5 applies to special structures outside the scope of the Standard, whose failure would pose a catastrophic risk to a large area or a large number of people. It has not been provided for in NZS 1170.5.
Building code/NZBC	The New Zealand Building Code, which specifies the required performance of buildings.
Capacity design	A method of ensuring a building will behave in a ductile manner if subjected to a major earthquake.
Characteristic strengths	There is variability in all material properties. To allow for this, material strengths are determined by tests on a large number of samples to measure the variation in properties. With the lower characteristic yield strength, 95 per cent of the samples have strengths exceeding this value. With the upper characteristic strength, five per cent of the strengths exceed the value.
Code, or code of practice	A document that specifies how a structure is to be designed. In New Zealand many codes of practice are developed by Standards Committees established and endorsed under the methodology and auspices of Standards New Zealand and these documents are referred to as Standards. (See also “NZ Standards” below).
Concentrically braced frame	The seismic or wind forces are transmitted to the foundation by direct axial forces in the bracing members.
Cone penetrometer test (CPT)	A means of assessing the in situ properties of a soil.
Confinement	Concrete is generally confined in potential plastic hinge zones. When concrete is close to its uni-axial unconfined strength it expands laterally. By enclosing the concrete with stirrups placed around longitudinal bars the stirrups are stressed when the lateral expansion occurs and they apply a confining force to the enclosed concrete. This increases both the compressive stress and the strain that can be sustained in the concrete. Confining concrete can have the advantage of enabling plastic hinges to sustain greater inelastic deformation before failure occurs, hence increasing ductility.

Damping	Structural damping refers to energy dissipation in the structure by friction between components in the building, and energy dissipated by movement between the foundations, supporting soils and other energy dissipated in the structural members. In terms of seismic design methods, NZS 1170.5 does not include energy dissipated by yielding of reinforcement or steel structural members, or the crushing of concrete.
DBE	Design-based earthquake used in design for ultimate limit state.
DEE	Detailed engineering evaluation, a detailed examination of a building and the building structural drawings to assess the seismic performance of the structure.
Design action	An action at a point in a building, such as a bending moment, a shear force, an axial load or a displacement, which has been found in an analysis. To satisfy design requirements the building must have the capacity to resist this action.
Design strength	The design strength is the nominal strength multiplied by the appropriate strength reduction factor.
Detailing	Arrangement of longitudinal and transverse reinforcement in a concrete member or the location of welds and stiffeners, etc., in structural steel members.
Diagonal cracking	Often referred to as shear cracking (see structural actions) in concrete and masonry members.
Diaphragm	A structural element that transmits in-plane forces (diaphragm forces) to and between lateral-force-resisting elements. In buildings, floors usually act as diaphragms and are occasionally called diaphragms. Diaphragm forces are the in-plane forces acting in a floor (diaphragm).
Displacement-based design	See section 3: Introduction to Seismic Design of Buildings, Volume 1 of this Report.
Double Tees	Precast prestressed units used in the construction of some floors.
Drag bars	Reinforcing bars placed in a floor slab to pick up lateral forces and transfer them to a lateral force resisting element.
Ductile detailing length	The length over which reinforcement in a plastic hinge may yield or concrete may crush.
Earthquake-prone building	An earthquake-prone building is defined by section 122 of the Building Act 2004 and associated regulations. In summary, an earthquake-prone building is one that, if assessed against current standards for the erection of new buildings, would be assessed as not satisfying more than 33 per cent of the minimum design actions for strength and ductility for the ultimate limit state.
Earthquake-risk building	A building is assessed as an earthquake-risk building if, when assessed against the minimum requirements in current buildings standards, it satisfies between 33 per cent and 67 per cent of the minimum design actions for strength and ductility for the ultimate limit state.
Eccentricity	In the context of this Report eccentricity refers to the distance between the centre of inertial force on a building and the centre of stiffness and/or strength of the lateral force resisting elements.
Eccentrically braced frame	A structural steel frame consisting of beam and columns but with diagonal bracing in one or more bays to reduce the magnitudes of the bending moments in the beams. The short section of beam between the diagonal braces is subjected to high shear forces and in a major earthquake this zone, known as an active link, yields in a ductile manner.
Element	A structural member such as a beam, column, wall or frame made up from beams and columns, that resist structural actions.

---

Effective section properties	Section properties, area and second moment of area used for calculating stress levels and deformation of structural elements. Effective properties in reinforced concrete are section properties based on gross section multiplied by a factor to allow for flexural cracking of concrete.
Elongation	See section 3: Introduction to Seismic Design of Buildings, Volume 1 of this Report.
Force-based design	See section 3: Introduction to Seismic Design of Buildings, Volume 1 of this Report.
Fundamental period	The fundamental period is the longest period of vibration, which corresponds to the direction being considered.
Gross section properties	Section properties based on the dimensions of the concrete section but neglecting reinforcement and cracking of concrete.
Hollow-core	Precast prestressed concrete units used in the construction of some floors.
In-plane and out-of-plane forces	Forces acting in the plane of a wall as distinct from out-of-plane forces, which act in a direction normal (at right angles) to the face of the wall.
IEP	Initial evaluation procedure, made to establish buildings that are likely to be earthquake-prone or earthquake-risk buildings.
Kinematic effects	Effects due to the motion of bodies.
Inertial force	Force induced by a mass that has been subjected to acceleration, such as occurs in an earthquake owing to ground motion.
Lateral-force-resisting element	A structural member such as a wall, or group of members such as a moment resisting frame, which is designed to provide lateral force resistance.
Low-damage or damage-avoidance design	Design to reduce the structural damage sustained in a major earthquake, for example, base isolation, PRESSS and non-tearing floor systems.
Material strain	A measure of the deformation of a section in a plastic hinge.
MCE	Maximum considered earthquake, generally taken as an earthquake with a return period of 2500 years for most multi-storey buildings. Multi-storey buildings designed to current New Zealand Standards are intended to have a small margin of safety against collapse in the MCE.
Moment resisting frame	A structural frame consisting of beams and columns designed to provide lateral force resistance to a building.
NBS	New Building Standard, which refers to the building standards in force at the time when an assessment of an existing building is made.
Nominal strength	The strength calculated assuming the materials in the member have their lower characteristic strengths.
NZ Standards (NZS)	Sets of rules used in the design of buildings. AS/NZS 1170 Parts 0 to 4 and NZS 1170.5, the Earthquake Actions Standard, define the required combination of strength, stiffness and ductility that a proposed building must be designed to satisfy, while the material Standards for Structural Concrete, Structural Steel or Structural Timber provide rules on how the requirements can be satisfied.
P-delta	See section 3: Introduction to Seismic Design of Buildings, Volume 1 of this Report.
Period	The time (in seconds) it takes for a structure to complete an oscillation cycle. Frequency is the inverse of period, that is the number of cycles per second.

---

---

Potential plastic hinge	See section 3: Introduction to Seismic Design of Buildings, Volume 1 of this Report.
Primary crack	A crack that forms in a reinforced concrete member when the stress due to bending exceeds the tensile strength of the concrete.
Probable strength	A strength calculated on the basis that the material strengths have their average values.
Rapid Assessment level 1 or 2	Rapid assessment made to see if a building has sustained damage in an earthquake. A Level 1 assessment is based on an inspection of the exterior of a building; Level 2 includes both an exterior and an interior inspection.
Return factor, R	A factor that varies with the return period of the design earthquake being considered.
Response spectra	A plot of the peak acceleration, or peak displacement, sustained by single degree of freedom structures with period. Design response spectra are given in design Standards (NZS 1170.5) and response spectra can be calculated from the ground motion recorded in an earthquake.
Return period	Refers to the average time in years between earthquakes which give a specified intensity of shaking at a specified location.
Secondary crack	A crack formed in a reinforced concrete member when the tension force transmitted across a crack by reinforcement exceeds the tensile strength of the concrete surrounding the reinforcement.
Section properties	Properties of members used for calculating stresses and deformations.
Serviceability limit state (SLS)	See section 3: Introduction to Seismic Design of Buildings, Volume 1 of this Report.
Shear core	A group of walls that are joined together and can resist lateral forces. Shear cores generally surround liftshafts and stairwells.
Shear force	See Section 3: Introduction to Seismic Design of Buildings, Volume 1 of this Report.
Shear wall or structural wall	A wall that is used to resist lateral forces induced by earthquake actions.
Single degree of freedom (SDOF)	A simple structural model that can only vibrate in one mode.
$S_p$ factor	Structural performance factor used to modify design response spectra.
Spectral shape factor	A set of values that defines the shape of the design spectra for different types of soils.
Standard penetration test (SPT)	A means of assessing the in situ properties of soil.
Strain	The change in length of a building element divided by its original length.
Strain ageing	Change in properties of steel that occurs with time (weeks) after the steel has been strained beyond its elastic limit (the yield strain).
Strain hardening	The increase in stress with increasing strain in reinforcement when the strain exceeds the yield strain.
Strength reduction factor	A factor that is applied to the nominal strength to give the design strength.
Stress	Force divided by the area of element resisting the force. For example, stress in reinforcement is equal to the force carried by the reinforcement divided by the area of reinforcement.

---

Torsion	Twisting of a structural member, or of a building as a whole. Generally in this report it refers to the building as a whole. Twisting results from the lateral inertial forces being displaced in plane view from the centre of lateral stiffness and strength.
Ultimate limit state	ULS, see section 3: Introduction to Seismic Design of Buildings, Volume 1 of this Report.
Ultimate strain	In reinforcement and structural steel members this is the strain that corresponds to maximum stress in a test where the strain is progressively increased.
Unreinforced masonry (URM)	Unreinforced masonry, including brick buildings and buildings built using stone masonry.
Web stiffener	An attached element that provides out-of-plane buckling restraint to the web of the member.
Yield strain	The strain at the limit of elastic response.



**Canterbury Earthquakes  
Royal Commission**  
Te Komihana Rūwhenua o Waitaha

**Canterbury Earthquakes  
Royal Commission**

PO Box 14053  
Christchurch Mail Centre 8544  
Christchurch  
New Zealand  
0800 337 468  
+64 3 741 3000  
[canterbury@royalcommission.govt.nz](mailto:canterbury@royalcommission.govt.nz)